



Unified
corporation



*Jewelry & Watch making
Optical Tools
Catalogue*





Chain Bent Nose Pliers

Size 130mm

786.000.01

With double leaf spring
Smooth Jaw
PVC handle

786.000.02

With double leaf spring
Serrated Jaw
PVC handle

786.000.03

Without leaf spring
Smooth Jaw
PVC handle

786.000.04

Without leaf spring
Serrated Jaw
PVC handle



Chain Nose Pliers

Size 130mm

786.001.01

With double leaf spring
Smooth Jaw
PVC handle

786.001.02

With double leaf spring
Serrated Jaw
PVC handle

786.001.03

Without leaf spring
Smooth Jaw
PVC handle

786.001.04

Without leaf spring
Serrated Jaw
PVC handle



Flat Nose Pliers

Size 130mm

786.002.01

With double leaf spring
Smooth Jaw
PVC handle

786.002.02

With double leaf spring
Serrated Jaw
PVC handle

786.002.03

Without leaf spring
Smooth Jaw
PVC handle

786.002.04

Without leaf spring
Serrated Jaw
PVC handle

Jaw width 4 mm, 5mm, 6 mm available



Round Nose Pliers

Size 130mm

786.003.01

With double leaf spring
Smooth Jaw
PVC handle

786.003.02

Without leaf spring
Smooth Jaw
PVC handle



Pliers are also available in kit

Flat & Half Round Pliers

Size 130mm

786.004.01

With double leaf spring

Smooth Jaw

PVC handle

786.004.02

Without leaf spring

Smooth Jaw

PVC handle

Jaw width 4 mm, 5 mm, 6 mm



Flat & Round Pliers

Size 130mm

786.005.01

With double leaf spring

Smooth Jaw

PVC handle

786.005.02

Without leaf spring

Smooth Jaw

PVC handle



Concave & Convex Forming Pliers

Size 130mm

786.006.01

With double leaf spring

Smooth Jaw

PVC handle

786.006.02

Without leaf spring

Smooth Jaw

PVC handle



Round & Concave Forming Pliers

Size 130mm

786.007.01

With double leaf spring

Smooth Jaw

PVC handle

786.007.02

Without leaf spring

Smooth Jaw

PVC handle





Side Cutter

Size 130mm

786.008.01

With double leaf spring
PVC handle
Semi Flush cut

786.008.02

Without leaf spring
PVC handles
Semi Flush cut

Flush Cutter are available for softer (copper) wire



Side Cutter, TC Tip

Size 130mm

786.009.01

With double leaf spring
PVC handles
Semi Flush cut

786.009.02

Without leaf spring
PVC handles
Semi Flush Cut

Flush Cutter are available for softer (copper) wire



End Cutter

Size 130mm

786.010.01

With double leaf spring
PVC handles
Semi Flush cut

786.010.02

Without leaf spring
PVC handles
Semi Flush cut

Flush Cutter are available for softer (copper) wire



End Cutter, TC Tip

Size 130mm

786.011.01

With double leaf spring
PVC handles
Semi Flush Cut

786.011.02

Without leaf spring
PVC handles
Semi Flush Cut

Flush Cutter are available for softer (copper) wire



Chain Bent Nose Pliers

Size 115mm

786.012.01

With double leaf spring
Smooth Jaw
PVC handle

786.012.02

With double leaf spring
Serrated Jaw
PVC handle

786.012.03

Without leaf spring
Smooth Jaw
PVC handle

786.012.04

Without leaf spring
Serrated Jaw
PVC handle

Chain Nose Pliers

Size 115mm

786.013.01

With double leaf spring
Smooth Jaw
PVC handle

786.013.02

With double leaf spring
Serrated Jaw
PVC handle

786.013.03

Without leaf spring
Smooth Jaw
PVC handle

786.013.04

Without leaf spring
Serrated Jaw
PVC handle

Flat Nose Pliers

Size 115mm

786.014.01

With double leaf spring
Smooth Jaw
PVC handle

786.014.02

With double leaf spring
Serrated Jaw
PVC handle

786.014.03

Without leaf spring
Smooth Jaw
PVC handle

786.014.04

Without leaf spring
Serrated Jaw
PVC handle

Round Nose Pliers

Size 115mm

786.015.01

With double leaf spring
Smooth Jaw
PVC handle

786.015.02

Without leaf spring
Smooth Jaw
PVC handle



Pliers are also available in kit



Flat & Half Round Pliers

Size 115mm

786.016.01

With double leaf spring
Smooth Jaw
PVC handle



786.016.02

Without leaf spring
Smooth Jaw
PVC handle



Flat & Round Pliers

Size 115mm

786.017.01

With double leaf spring
Smooth Jaw
PVC handle



786.017.02

Without leaf spring
Smooth Jaw
PVC handle



Concave & Convex Pliers

Size 115mm

786.018.01

With double leaf spring
Smooth Jaw
PVC handle



786.018.02

Without leaf spring
Smooth Jaw
PVC handle



Side Cutter, with screw joint

Size 115mm

Double grip, Non slip

786.019.01

With double leaf spring
Matt handle
Semi Flush cut



786.019.02

Without leaf spring
Matt handle
Semi Flush cut

Flush cutters are available for softer (copper) wire



Pliers are also available in kit

Side Cutter

Size 115mm

786.020.01

With double leaf spring

PVC handle

Semi Flush Cut

786.020.02

Without leaf spring

PVC handles

Semi Flush Cut

Flush Cutter are available for softer (copper) wire



Side Cutter, TC Tip

Size 115mm

786.021.01

With double leaf spring

PVC handles

Semi Flush cut

786.021.02

Without leaf spring

PVC handles

Semi Flush cut

Flush Cutter are available for softer (copper) wire



End Cutter

Size 115mm

786.022.01

With double leaf spring

PVC handles

Semi Flush cut

786.022.02

Without leaf spring

PVC handles

Semi Flush cut

Flush Cutter are available for softer (copper) wire



End Cutter, TC Tip

Size 115mm

786.023.01

With double leaf spring

PVC handles

Semi Flush cut

786.023.02

Without leaf spring

PVC handles

Semi Flush cut

Flush Cutter are available for softer (copper) wire





Chain Bent Nose Pliers

Size 115mm

786.024.01

With double leaf spring
Smooth Jaw
PVC handle



Chain Nose Pliers

Size 115mm

786.025.01

With double leaf spring
Smooth Jaw
PVC handle



Flat Nose Pliers

Size 115mm

786.026.01

With double leaf spring
Smooth Jaw
PVC handle



Round Nose Pliers

Size 115mm

786.027.01

With double leaf spring
Smooth Jaw
PVC handle



Side Cutter

Size 115mm

786.028.01

With double leaf spring
PVC handle



End Cutter

Size 115mm

786.029.01

With double leaf spring
PVC handle



Set of 4 Pliers on wooden Stand

Size 115mm

Kit contains Chain Nose,
Flat Nose, Round Nose & Side Cutter

786.030.01

With double leaf spring
PVC handle





Chain Nose Pliers

Size 115mm

786.031.01

With single leaf spring
Smooth Jaw
PVC handle



Flat Nose Pliers

Size 115mm

786.032.01

With single leaf spring
Smooth Jaw
PVC handle



Round Nose Pliers

Size 115mm

786.033.01

With single leaf spring
Smooth Jaw
PVC handle



Side Cutter

Size 115mm

786.034.01

With single leaf spring
PVC handle



Chain Nose Pliers

Size 133mm

786.035.01

With double leaf spring
Smooth Jaw
PVC handle



Flat Nose Pliers

Size 133mm

786.036.01

With double leaf spring
Smooth Jaw
PVC handle



Round Nose Pliers

Size 133mm

786.037.01

With double leaf spring
Smooth Jaw
PVC handle

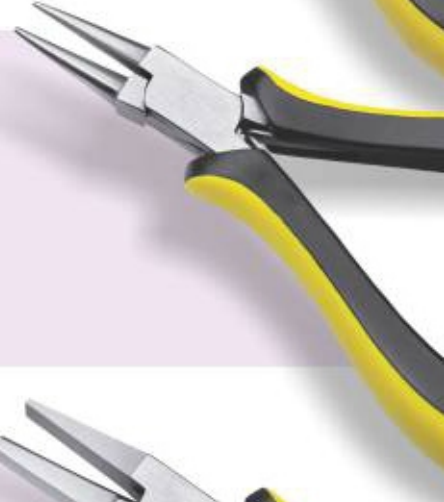

Flat & Half Round

Size 133mm

786.038.01

With double leaf spring
Smooth Jaw
PVC handle



Pliers are also available in kit



Round & Flat Nose Pliers

Size 133mm

786.039.01

With double leaf spring
Smooth Jaw
yellow & black



Side Cutter

Size 133mm

786.040.01

With double leaf spring
Smooth Jaw
yellow & black



Side Cutter, TC Tip

Size 133mm

786.041.01

With double leaf spring
Smooth Jaw
yellow & black



End Cutter

Size 133mm

786.042.01

With double leaf spring
Smooth Jaw
yellow & black



End Cutter, TC Tip

Size 133mm

786.043.01

With double leaf spring
Smooth Jaw
yellow & black



Note: Other Colors of Handles are available
A-Grey & Black, B-Red & Black, C-Blue & Black

Chain Nose Pliers

Size 120mm

786.044.01

With double leaf spring
Smooth Jaw
yellow & black



Flat Nose Pliers

Size 120mm

786.045.01

With double leaf spring
Smooth Jaw
yellow & black

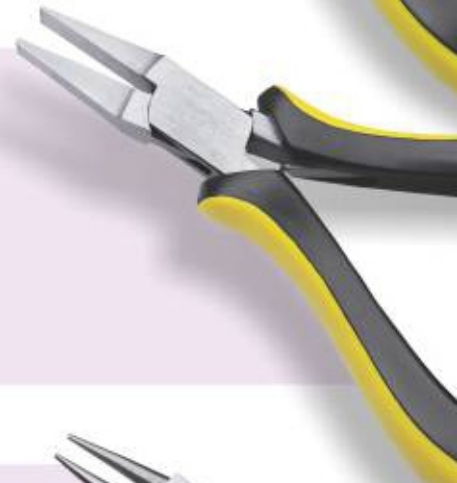

Round Nose Pliers

Size 120mm

786.046.01

With double leaf spring
Smooth Jaw
yellow & black



Side Cutter

Size 120mm

786.047.01

With double leaf spring
Smooth Jaw
yellow & black



Note: Other Colors of Handles are available
A-Grey & Black, B-Red & Black, C-Blue & Black
Pliers are also available in kit



Chain Nose Pliers

Size 135mm

786.048.01
with Double Leaf Spring
Special Matt Handle



Flat Nose Pliers

Size 135mm

786.049.01
with Double Leaf Spring
Special Matt Handle



Round Nose Pliers

Size 135mm

786.050.01
with Double Leaf Spring
Special Matt Handle



Flat & Half Round Plier



Size 135mm

786.051.01

with Double Leaf Spring
Special Matt Handle

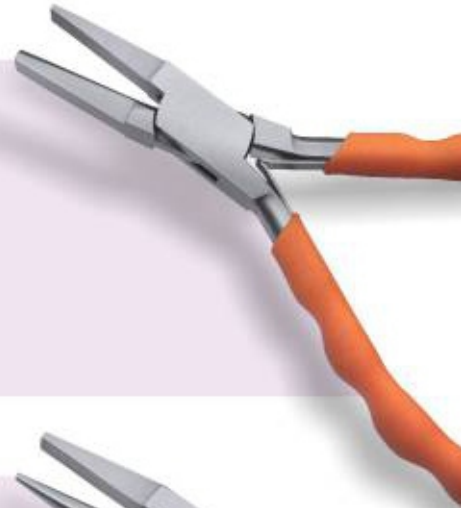

Round + Half Plier



Size 135mm

786.052.01

with Double Leaf Spring
Special Matt Handle



Side Cutter



Size 135mm

786.053.01

with Double Leaf Spring
Special Matt Handle





Chain Long Nose Pliers

Size 140mm

786.054.01

Double leaf spring
special white moulded handles



Flat Long Nose Pliers

Size 130mm

786.055.01

Double leaf spring
special white moulded handles



Round Long Nose Pliers

Size 130mm

786.056.01

Double leaf spring
special white moulded handles



Note: High Quality Precision Pliers

Chain Nose Pliers

Size 120mm

786.057.01

Double leaf spring
special white moulded handles



Flat Nose Pliers

Size 120mm

786.058.01

Double leaf spring
special white moulded handles



Round Nose Pliers

Size 120mm

786.059.01

Double leaf spring
special white moulded handles



Side Cutter

Size 120mm

786.060.01

Double leaf spring
special white moulded handles



Note: High Quality Precision Pliers



Chain Nose Pliers

Size 120mm

786.061.01

Double leaf spring
special red & black moulded handles



Flat Nose Pliers

Size 120mm

786.062.01

Double leaf spring
special red & black moulded handles



Round Nose Pliers

Size 120mm

786.063.01

Double leaf spring
special red & black moulded handles



Note: High Quality Precision Pliers
Different Colors of Handles are available
A-Yellow & Black, B-Grey & Black, C-Blue & Black

Pliers are also available in kit

Flat & Round pliers

Size 120mm

786.064.01

Double leaf spring
special red & black moulded handles



Side Cutter

Size 120mm

786.065.01

Double leaf spring
special red & black moulded handles



Side Cutter

Double leaf spring
special Moulded Black Handle

786.066.12

Size 120 mm

786.066.14

Size 140 mm



Note: High Quality Precision Pliers
Different Colors of Handles are available
A-Yellow & Black, B-Grey & Black, C-Blue & Black

Chain Bent Nose Pliers

Size 140mm

786.067.01

With spring

Chain Nose Pliers

Size 140mm

786.068.01

With spring

Flat Nose Pliers

Size 140mm

786.069.01

With spring

Round Nose Pliers

Size 140mm

786.070.01

With spring



Split Ring Pliers

Size 140mm

786.071.01

With spring



Bead Crimping Pliers

Size 140mm

786.072.01

With spring



Bead Crimping Pliers

Size 135mm

786.073.01

With spring



Side Cutter, Flush Cutter

Size 140mm

786.074.01

With spring



Memory wire Cutter

Size 130mm

786.075.01

With spring





Chain Nose Pliers

Size 133mm

786.076.01

Special Grooved handle



Flat Nose Pliers

Size 133mm

786.077.01

Special Grooved handle



Round Nose Pliers

Size 133mm

786.078.01

Special Grooved handle



Flat & Half Round

Size 133mm

786.079.01

Special Grooved handle



Side Cutter

Size 133mm

786.080.01

Special Grooved handle



End Cutter

Size 133mm

786.081.01

Special Grooved handle



Set of 4 Pliers on wooden Stand

Size 133mm

Kit contains Chain Nose,
Flat Nose, Round Nose & Side Cutter

786.082.01

With double leaf spring
Smooth Jaw, PVC handle



Chain Nose Pliers



Size 130mm

786.083.01

Smooth Handles
Polish, Semi Matt Finish

Flat Nose Pliers



Size 130mm

786.084.01

Smooth Handles
Polish, Semi Matt Finish

Jaw width 4 mm, 5 mm, 6 mm available

Round Nose Pliers



Size 130mm

786.085.01

Smooth Handles
Polish, Semi Matt Finish

Flat & Half Round Forming Pliers



Size 130mm

786.086.01

Smooth Handles
Polish, Semi Matt Finish

Jaw width 4 mm, 5 mm, 6 mm available



Round & Flat Forming Pliers

Size 130mm

786.087.01

Smooth Handles
Polish, Semi Matt Finish



Round & Concave Forming Pliers

Size 130mm

786.088.01

Smooth Handles
Polish, Semi Matt Finish



Concave & Convex Forming Pliers

Size 130mm

786.089.01

Smooth Handles
Polish, Semi Matt Finish



Side Cutter

Size 130mm

786.090.01

Smooth Handles
Polish, Semi Matt Finish





Side Cutter - TC

Size 130mm

786.091.01

Smooth Handles
Polish, Semi Matt Finish



End Cutter

Size 130mm

786.092.01

Smooth Handles
Polish, Semi Matt Finish



End Cutter - TC

Size 130mm

786.093.01

Smooth Handles
Polish, Semi Matt Finish



Oblique Cutter

Size 125mm

786.094.01

Smooth Handles
Polish, Semi Matt Finish



Chain Nose Pliers

Size 115mm

786.095.01

Smooth Handles
Polish, Semi Matt Finish



Flat Nose Pliers

Size 115mm

786.096.01

Smooth Handles
Polish, Semi Matt Finish



Round Nose Pliers

Size 115mm

786.097.01

Smooth Handles
Polish, Semi Matt Finish



Side Cutter

Size 115mm

786.098.01

Smooth Handles
Polish, Semi Matt Finish





Side Cutter

Size 115mm

786.099.01

Smooth Handles
Polish, Semi Matt Finish
With Tungsten Carbide Inserts

TC



End Cutter

Size 115mm

786.100.01

Smooth Handles
Polish, Semi Matt Finish



End Cutter

Size 130mm

786.101.01

Smooth Handles
Polish, Semi Matt Finish
With Tungsten Carbide Inserts

TC



Chain Bent Long Nose Pliers

Size 140mm

786.102.01

Double Leaf Spring
PVC Coated Handles



Chain Long Nose Pliers

Size 140mm

786.103.01

Double Leaf Spring
PVC Coated Handles



Flat Long Nose Pliers

Size 140mm

786.104.01

Double Leaf Spring
PVC Coated Handles



Round Long Nose Pliers

Size 140mm

786.105.01

Double Leaf Spring
PVC Coated Handles



Round & Flat Nose Pliers

Size 140mm

Oval Pliers

786.106.01

Double Leaf Spring
PVC Coated Handles





Chain Nose Pliers

Size 160mm

786.107.01

PVC Coated Handles



Flat Nose Pliers

Size 160mm

786.108.01

PVC Coated Handles



Round Nose Pliers

Size 160mm

786.109.01

PVC Coated Handles



Flat & Half Round Forming Pliers

Size 160mm

786.110.01

PVC Coated Handles



Concave & Convex Pliers

Size 160mm

786.111.01

PVC Coated Handles



Flat & Round Forming Pliers

Size 160mm

786.112.01

PVC Coated Handles



Side Cutter

Size 160mm

786.113.01

PVC Coated Handles

786.113.02

PVC Coated Handles
Tungsten Carbide Inserts



Ring Bending Pliers

Size 162mm

786.114.01

PVC Coated Handles





Flat Nose Brass Jaw Pliers

Size 140mm

786.115.01

PVC Coated Handles



Bending Pliers

Size 140mm

786.116.01

PVC Coated Handles



Ring Bending Pliers

Size 140mm
Brass V- Slot

786.117.01

PVC Coated Handles



Ring Bending Pliers

Size 170mm

786.118.01

PVC Coated Handles



Steel Ring Bending Pliers

Size 170mm
Box Joint Construction Heavy

786.119.01



Ring Bending Pliers

Size 170mm
German Style

786.120.01



Ring Bending Pliers

Size 170mm
Swiss Style
Light Weight Easy To Work

786.121.01





Ring Holding Plier

Size 140mm

786.122.01



Ring Holding Plier

Size 140mm

786.123.01

With Leather

786.123.02

Without Leather



Ring Holding Plier

Size 150mm

With Adjustable Screw

786.124.01



Flat Nose Plier

Size 130mm

With Hole

786.125.01



Groovy Plier

Size 130mm

786.126.01

With Double Leaf Spring
PVC Coated Handle



Prong Lifting Pliers

Size 140mm

786.127.01



Prong Lifter

Tempered Steel, Highly Sharpened

786.128.01

With Handle
PVC Coated

786.128.02

Without Handle

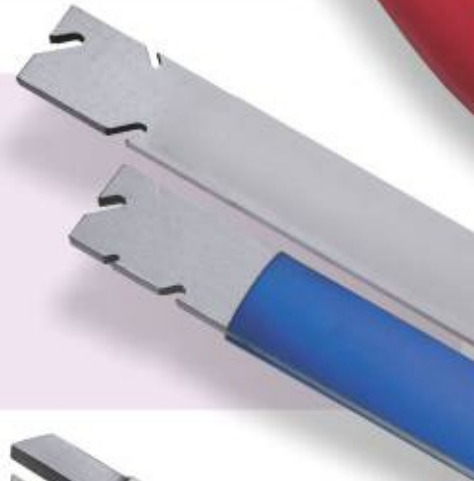

Stone Setting Pliers

Size 125mm

786.129.01

With double leaf spring
PVC Coated Handle



Rosary Pliers

Size 140mm

786.130.01

With double leaf spring
PVC Coated Handle





Crimping Pliers

Size 130mm
Multiple Crimps Can be Created

786.131.01

With double leaf spring
PVC Coated Handle



Single Crimping Pliers

Size 130mm

786.132.01

With double leaf spring
PVC Coated Handle



Loop Closing Pliers

Size 140mm

786.133.01

PVC Coated Handle



Chain Bent Nose Plier

Size 130mm

786.134.01

With double leaf spring
PVC Coated Handle

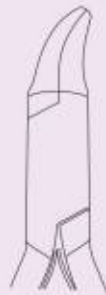



Gem Setting Pliers

786.135.01



Ring Opening Pliers

Size 140mm

786.136.01

With double leaf spring
PVC Coated Handle



Chain With Cutter

Size 130mm

786.137.01

With double leaf spring
PVC Coated Handle



Ring Holder

786.138.01





Wire Looping Pliers

Size 140mm

786.139.01

3 Step Round
Other Side Convex



Wire Looping Pliers

Size 140mm

786.140.01

3 Step Round
Other Side Chain Nose



Wire Looping Pliers

Size 140mm

786.141.01

3 Step Round
Other Side Flat Nose



Flat Plier with 3 Steps

Size 130mm

786.142.01

Flat Pliers with 3 steps
6mm, 4mm, 2mm





6 Steps Pliers



Size 145mm

786.143.01

1.8 mm, 2.5 mm, 4 mm,
5 mm, 7 mm & 8.5 mm

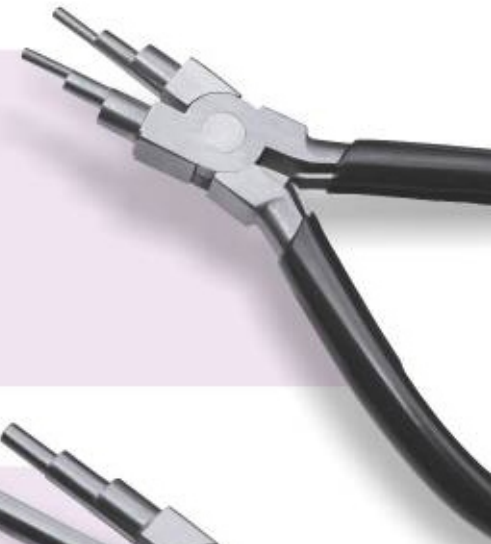

Wrap & Tap Pliers



Size 165mm

786.144.01

Barrel Diameter 5 mm,
7 mm & 10 mm



Wrap & Tap Pliers



Size 165mm

786.145.01

Barrel Diameter 13 mm,
16 mm & 20 mm

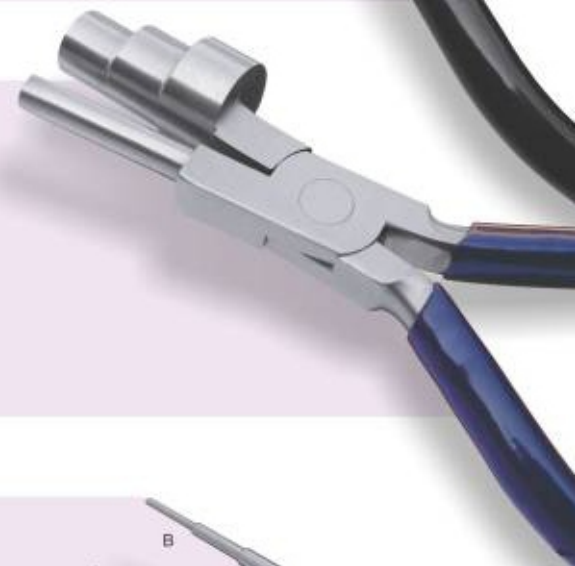

2 Ring Mandrel



786.146.01

A-Size 6, 7, 8, 9, 10 mm

786.146.02

B-Size 1.5, 2.5, 3.5, 4.5, 5 mm

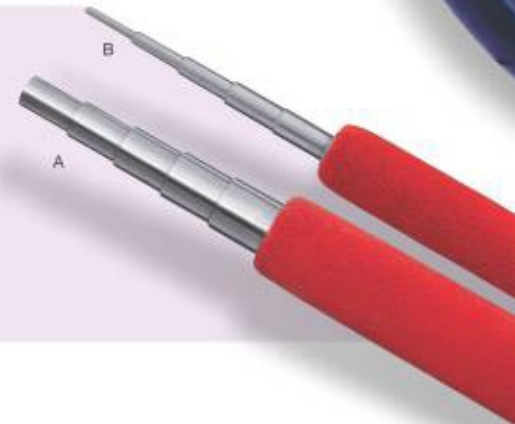



Bail Making Pliers

Size 150mm

786.147.01

6 mm & 8.5 mm Jaw, Length 35 mm
With Double Leaf Spring
PVC Coated Handle

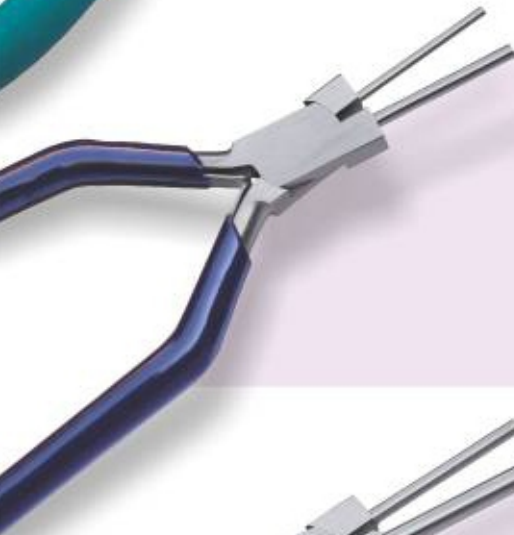

Bail Making Pliers

Size 160mm

786.148.01

2 mm & 2.5 mm
Ergo Handle

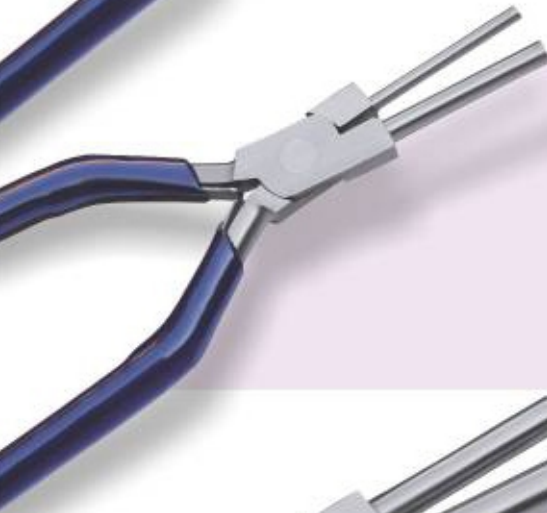

Bail Making Pliers

Size 160mm

786.149.01

3 mm & 5 mm
Ergo Handle



Bail Making Pliers

Size 160mm

786.150.01

7 mm & 9 mm
Ergo Handle



Knotting Tool Red Color



786.151.01

Knotting Tool Black Color



786.152.01

Dimple Pliers or Dapping Pliers



Size 130mm

786.153.01

Size of Dimple 1 mm
Double Leaf Spring
PVC Coated Handle

Dimple Pliers or Dapping Pliers



Size 130mm

786.154.01

Size of Dimple 1 mm
Double Leaf Spring
PVC Coated Handle

786.154.03

Size of Dimple 3 mm
Double Leaf Spring
PVC Coated Handle

786.154.05

Size of Dimple 5 mm
Double Leaf Spring
PVC Coated Handle

786.154.07

Size of Dimple 7 mm
Double Leaf Spring
PVC Coated Handle





Tube Holding Pliers

Size 170mm

786.155.01

Jaw can hold tube from
2 mm to 10 mm

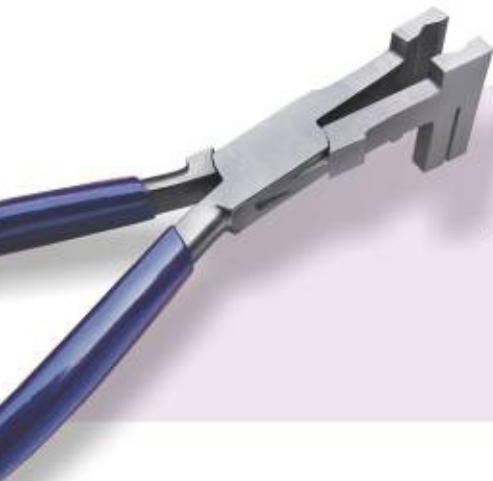

Coil Cutting Pliers

Size 170mm

786.156.01

L-Type Pliers
Coil size From 4.5 mm To 9 mm



Flat Wide Jaw Pliers

Size 160mm

786.157.01

Jaw width 32 mm



Chain Nose Pliers



Size 117mm

786.158.01

Double Spring
PVC Coated Handles



Flat Nose Pliers



Size 117mm

786.159.01

Double Spring
PVC Coated Handles



Round Nose Pliers



Size 117mm

786.160.01

Double Spring
PVC Coated Handles



Round Flat Nose Pliers



Size 117mm

786.161.01

Double Spring
PVC Coated Handles





Flat Nose Pliers

Size 150mm

786.162.01

Jaw width 8 mm

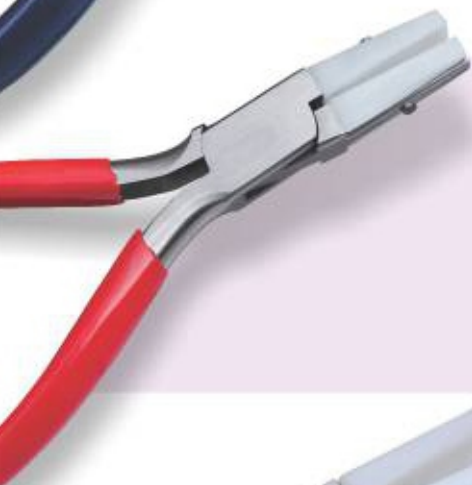

Flat Nose Pliers

Size 140mm

786.163.07

Jaw width 7 mm

786.163.11

Jaw width 11 mm



Flat Nose Pliers

Size 140mm

786.164.07

Jaw width 7 mm

786.164.11

Jaw width 11 mm



Flat & Half Round

Size 140mm

786.165.06

Jaw width 6 mm





Flat & Half Round Pliers



Size 140mm

786.166.06

Jaw width 6 mm



Round & Flat Pliers

Size 140mm

786.167.06

Jaw width 6 mm

Cushion Grip Handle



Bending Pliers

Size 140mm

786.168.24

Jaw width 24 mm



Tube Holding Pliers



Size 160mm

786.169.01

Jaw width & Hole sizes





Ring Holding

Size 140mm

786.170.01

Cushion Grip Handles



Bending Pliers

Size 140mm

786.171.01

Cushion Grip Handles



Bending Pliers

Size 140mm

786.172.01

Cushion Grip Handles



Wire Bending Plier

Size 140mm

786.173.01

PVC Coated Grip Handles





Snip

Size 170mm



786.174.01

Straight Blade

With spring & Lock System



786.174.02

Curved Blade

With spring & Lock System



Snip

Size 170mm



786.175.01

Straight Blade



786.175.02

Curved Blade



Snip

Size 170mm
With PVC Coating



786.176.01

Straight Blade



786.176.02

Curved Blade



Snip

Size 170mm



786.177.01

Straight Blade



786.177.02

Curved Blade





Snip

Size 160mm

786.178.16



Snip

Size 140mm

786.179.14



Snip

Straight Blade
Wide Blade

786.180.18

Size 180mm

786.180.16

Size 160mm



Snip

Size 140mm

786.181.14

Pointed Nose





Scissors

Size 140mm

786.182.14

Tough cut



Scissors

Size 130mm

786.183.13

Tough cut



Crown Scissors

Size 110mm

786.184.11

786.184.12

One Serrated Blade



Utility Scissors

Size 120mm

786.185.14



Utility Scissors

Size 140mm

786.186.14

Pointed Nose





Beading Scissors

Size 120mm

786.187.01

Straight Blade



786.187.02

Curved Blade



Thread Cutter

786.188.01



Thread Cutter

786.189.01

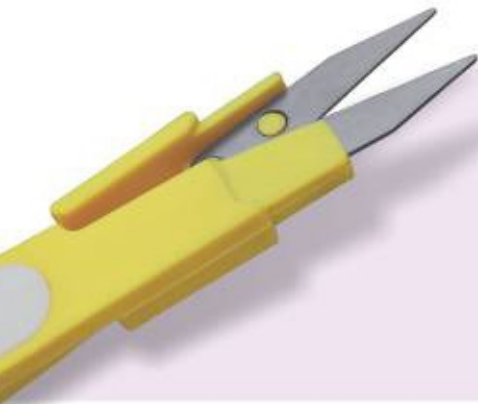

Thread Cutter

786.190.01



Ring Cutter

Size 170mm

786.191.01

Complete, PVC Grip

786.191.02

Spare Blade

786.191.03

Spare Key



Ring Cutter

Size 170mm

786.192.01

Complete

786.192.02

Spare Blade

786.192.03

Spare Key

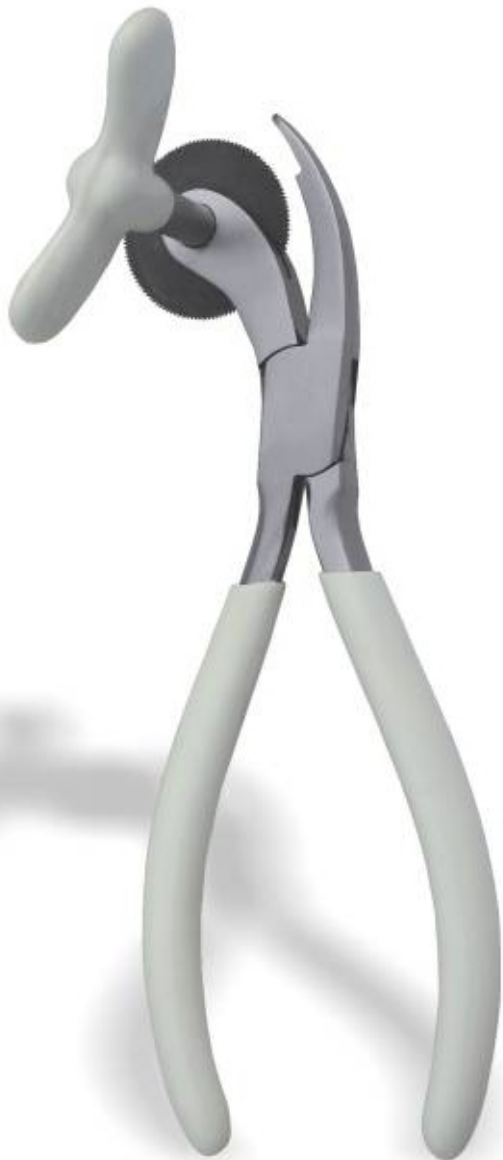

Ring Cutter

Size 140mm

786.193.01

Complete

786.193.02

Spare Blade

786.193.03

Spare Key



Ring Cutter

Size 130mm

786.194.01

Complete

786.194.02

Spare Blade

786.194.03

Spare Key

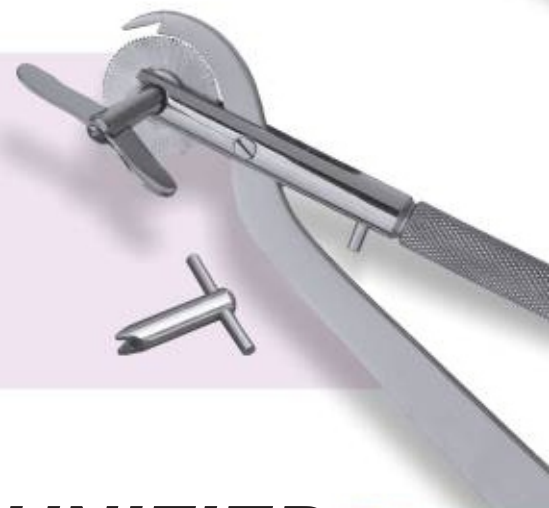



Side Cutter

Size 250mm

786.196.01

Heavy cutters



Side Cutter

Size 170mm

786.197.01

Side Cutter
With TC Tip

786.197.02



End Cutter

Size 170mm

786.198.01

End Cutter
With TC Tip

786.198.02



Side Cutter

Size 170mm

786.199.01



Sprue Side Cutter
Size 255mm

786.195.01

Sprue End Cutter
Size 255mm

786.195.02

Chain Nose Parallel Pliers

Size 140mm

786.500.01

Smooth Jaw

Jaws are Parallel from Bottom to Top



Chain Nose Parallel Pliers

Size 140mm

786.501.01

Serrated Jaw with V-Slot

Jaws are Parallel from Bottom to Top



Chain Nose Parallel Pliers

Size 120mm

786.502.01

Smooth Jaw

Jaws are Parallel from Bottom to Top



Chain Nose Parallel Pliers

Size 120mm

786.503.01

Serrated Jaw with V-Slot

Jaws are Parallel from Bottom to Top





Flat Nose Parallel Pliers

Size 140mm

786.504.01

Smooth Jaw

Without Spring

Jaws are Parallel from Bottom to Top



Flat Nose Parallel Pliers

Size 140mm

786.505.01

Serrated Jaw with V-Slot

With Spring

Jaws are Parallel from Bottom to Top



Flat Nose Parallel Pliers

Size 140mm

786.506.01

Smooth Jaw, Without Spring

786.506.02

Without Spring

Serrated Jaw & V-Slot

Jaws are Parallel from Bottom to Top



Flat Nose Parallel Pliers

Size 140mm

786.507.01

Extra Wide & Smooth Jaw

With Spring

Jaws are Parallel from Bottom to Top



Parallel Flat Brass Jaw Pliers



Size 140mm

786.508.01

Smooth Jaw
With Spring
Jaws are Parallel from Bottom to Top



Parallel Flat & Half Round Pliers



Size 140mm

786.509.01

Smooth Jaw
With Spring
Jaws are Parallel from Bottom to Top



Parallel Concave & Convex Pliers



Size 140mm

786.510.01

With Spring
Jaws are Parallel from Bottom to Top



Parallel Round & Flat Pliers



Size 140mm

786.511.01

Smooth Jaw
With Spring
Jaws are Parallel from Bottom to Top





Punch Parallel Pliers

Size 140mm
Pin Size 2 mm

786.512.01

Smooth Jaw
Without Spring

786.512.02

Spare Pin
(Pack of 6 Pins)



Side Cutter

Size 140mm

786.513.01

With Spring



Side Cutter with Lock

Size 170mm

786.514.01

With Spring



Side Cutter with Lock

Size 170mm

786.515.01



Flat Nose Parallel Pliers

Size 120mm

786.516.01

Smooth Jaw
Without Spring

Jaws are Parallel from Bottom to Top



Flat Nose Parallel Pliers

Size 120mm

786.517.01

Serrated Jaw
Without Spring



Combination Flat with Cutter

Size 120mm

786.518.01

Serrated Jaw, Flat Nose with V-Slot
and Combination of Side Cutter
Without Spring



Flat Plastic Jaw Parallel Plier

Size 120 mm

786.519.08

Jaws are Parallel from Bottom to Top

786.519.02

Spare Plastic Jaws





Flat Nose Parallel Pliers

Size 170mm

786.521.01

Smooth Jaw
With Spring

786.521.02

Serrated Jaw
With Spring



Grip Plier

Size 12"

786.522.12



Grip Plier

Size 9"

786.523.09



Holding Forceps

Size 6"

786.524.01

Straight

786.524.02

Curved

Universal Holder for Engravers

786.525.02

With 4 steel removable point.



Flat Nose Plastic Parallel Pliers Size 170mm

786.520.01

Holding Screw
With Spring

Hand Vices

Size 160mm

786.527.01

Serrated Jaw

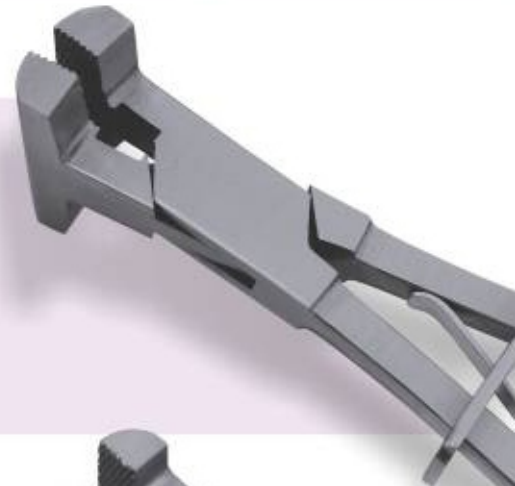

Hand Vices

Size 140mm

786.528.01

Serrated Jaw



Hand Vices

Size 130mm

786.529.01

Serrated Jaw

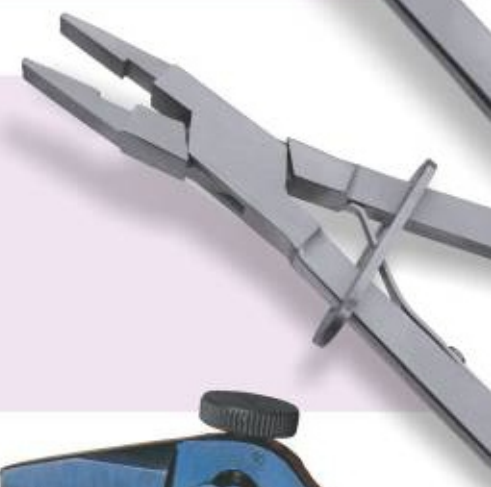

Hand Vices, Holding Pliers

Size 150mm

786.530.01

With locking System



Hand Vices, Holding Pliers
Size 150mm

786.526.02

With Brass Lined Jaw

With locking System



Pin Vices
Size 130mm

786.532.16
Jaw width 16 mm



Pin Vices
Size 140mm

786.531.24
Jaw width 24 mm



Pin Vices
Size 130mm

786.534.L



Pin Vices
Size 130mm

786.533.08
Jaw width 8 mm



Pin Vices
Size 130mm

786.536.01



Pin Vices
Size 130mm

786.535.S



Double Ended Pin Vices
Size 130mm

786.537.01
Economical Brass Jaw

786.537.02
Steel Jaw with Better Quality A Grade

Swivel Head Pin Vices

786.538.01



Blade Holder

786.539.01



Stone Picker

786.540.01



Stone Picker

786.541.01



Bead Scop

786.542.01



Bead Tray

786.543.01
Set of 3 trays



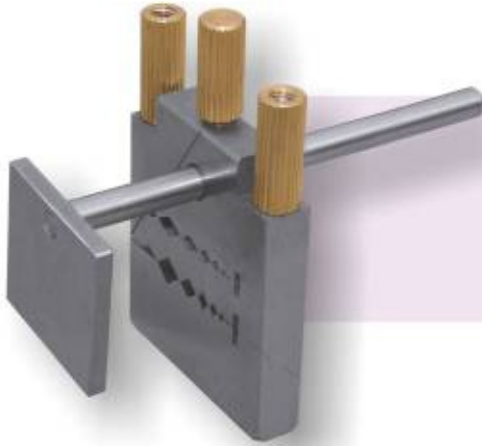

5 Angle Big Joint Cutter
Size 3" x 2" x 12 mm

786.544.01

5-Way Cutting Angles
45°, 60°, 90°, 120° & 135°
Hardness 62 HRC

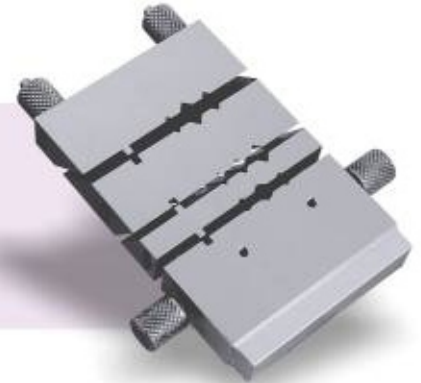

3 Angle Joint Cutter
Size 1 3/4" x 2 3/4" x 12 mm

786.545.01

3-Way Cutting Angles
45°, 60°, 90°
Hardness 62 HRC

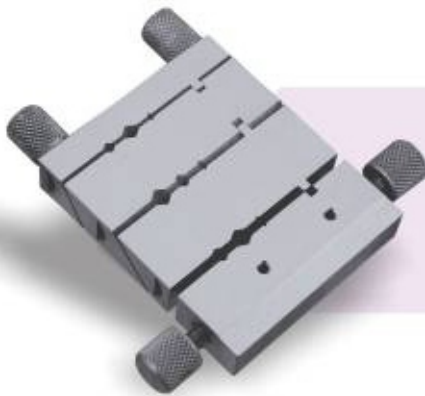

3 Angle Joint Cutter
Size 2" x 2" x 12 mm

786.545.02

3-Way Cutting Angles
45°, 60° & 90°
Hardness 62 HRC



2 Angle Joint Cutter
Size 1 3/4" x 2 3/4" x 12 mm

786.546.01

With Hex Key & Allan Rod
2-Way Cutting Angles
45° & 90°
Hardness 62 HRC

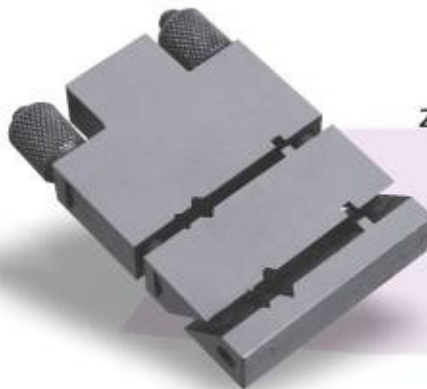

2 Angle Joint Cutter
Size 50 x 45 x 12 mm

786.547.01

2-Way Cutting Angles
30°, 45° & 90°
Hardness 62 HRC



2 Angle Joint Cutter
Size 50 x 75 x 12mm

786.548.01

2-Way Cutting Angles
30°, 45° & 90°

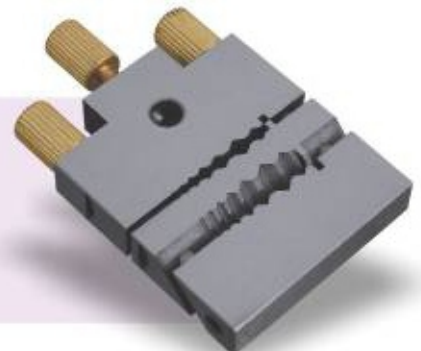

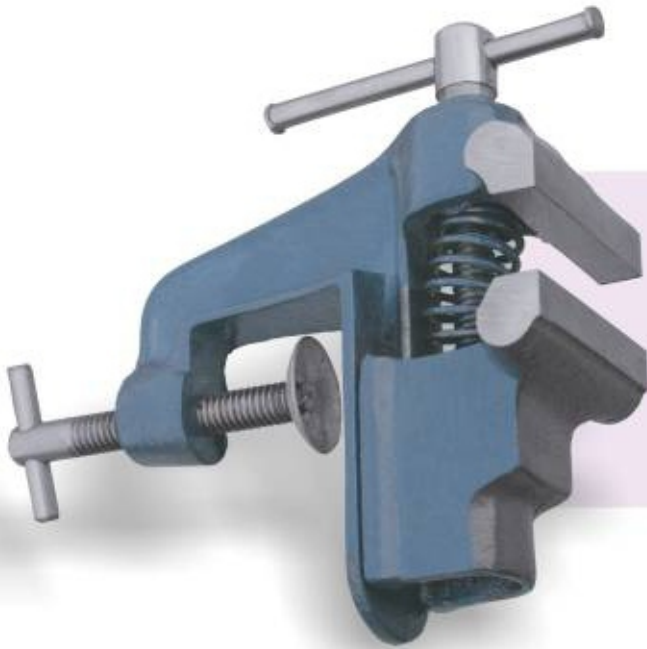

Small Bench Vice

Jaw width 24 mm

786.549.24

Smooth jaw

Hand Vice

786.550.01



Bench Vice

786.551.01

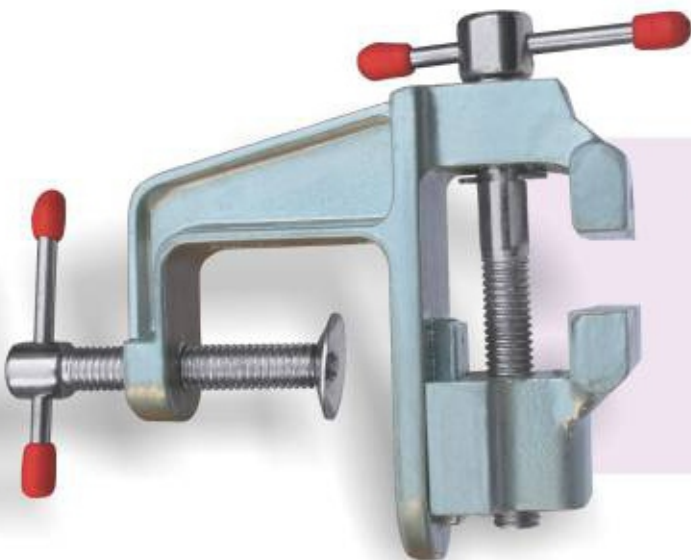



Saw Frame

786.552.60

Size 60mm

786.552.80

Size 80mm

786.552.100

Size 100mm

786.552.120

Size 120mm

Saw Frame With Adjustable Screw

786.553.60

Size 60mm

786.553.80

Size 80mm

786.553.100

Size 100mm

786.553.120

Size 120mm

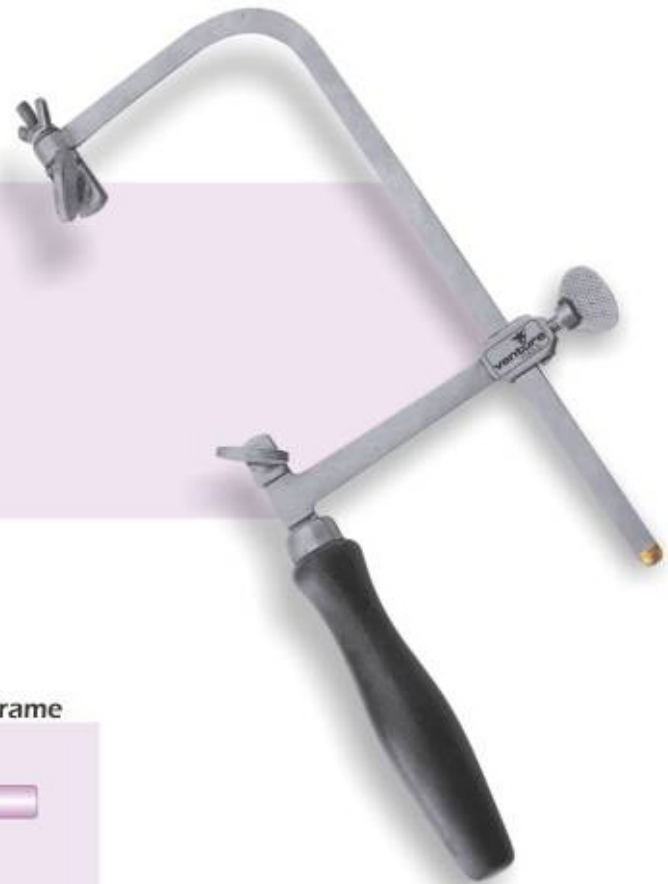

Saw Frame

Fixed

786.554.01

Making Pliers

786.555.01

786.555.925

Stamp 925

786.555.9K

9 K

786.555.12K

12 K

786.555.SL

Silver



Making Stamp

786.556.01



Mill Grain Wheel

Size 1-15

786.557.01



Tool Scriber

786.558.01

Sharp Point



Horn Anvil



786.559.01

Flat Surface, Hole on the Top
One Side Flat Horn
Other Side Round

Anvil with Stand



786.560.01

Flat Surface, Hole on the Top
One Side Flat Horn
Other Side Round

Drill Press



786.561.01

Ring Stretcher



786.562.01



Single Ended Cushion Grip Wax Carver

786.564.01

Double Ended Wax Carver

786.563.01
Hallow Handle, Light Weight



Scalpel Handle

No.4
786.565.01



Scalpel Handle

No.5
786.566.01



Titanium Soldering Pick

786.567.01



Set 10 Pcs Wax Carver
Different Shapes

786.568.01



Precision Wax Carver set
Set of 7 Pieces Silicone Handle

786.569.01





Jar Holding Pliers
Can Hold Round Large Jar

786.570.01



Jar Holding Pliers
Can Hold Square Large Jar

786.571.01



Jar Holding Pliers
Can Hold Square Small Jar

786.572.01

Jar Holding Pliers

786.573.01



Jar Holding Pliers

786.574.01

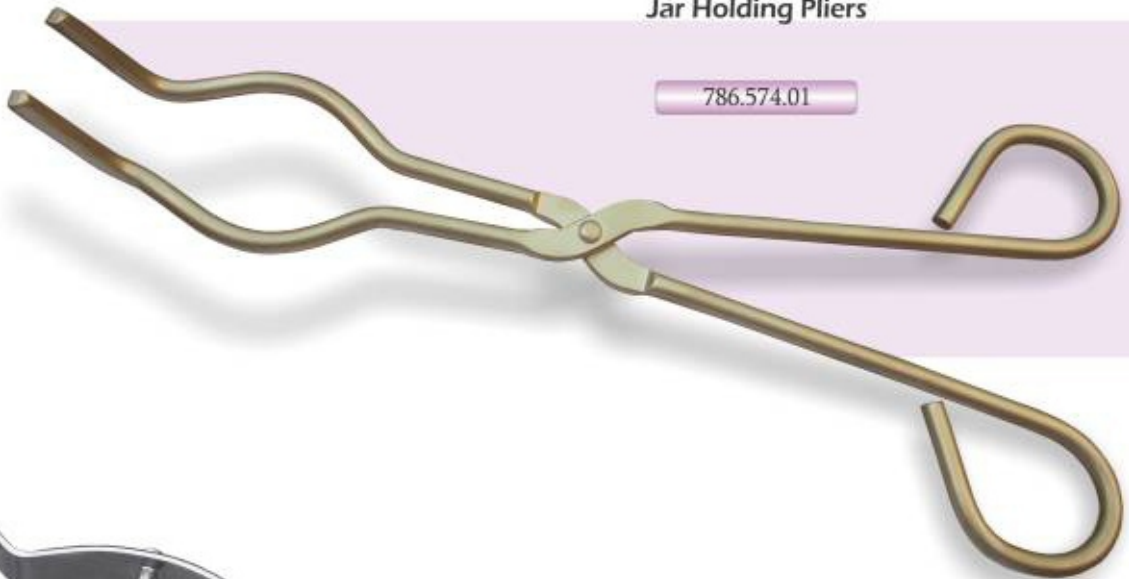

Flux -Tong

786.575.01

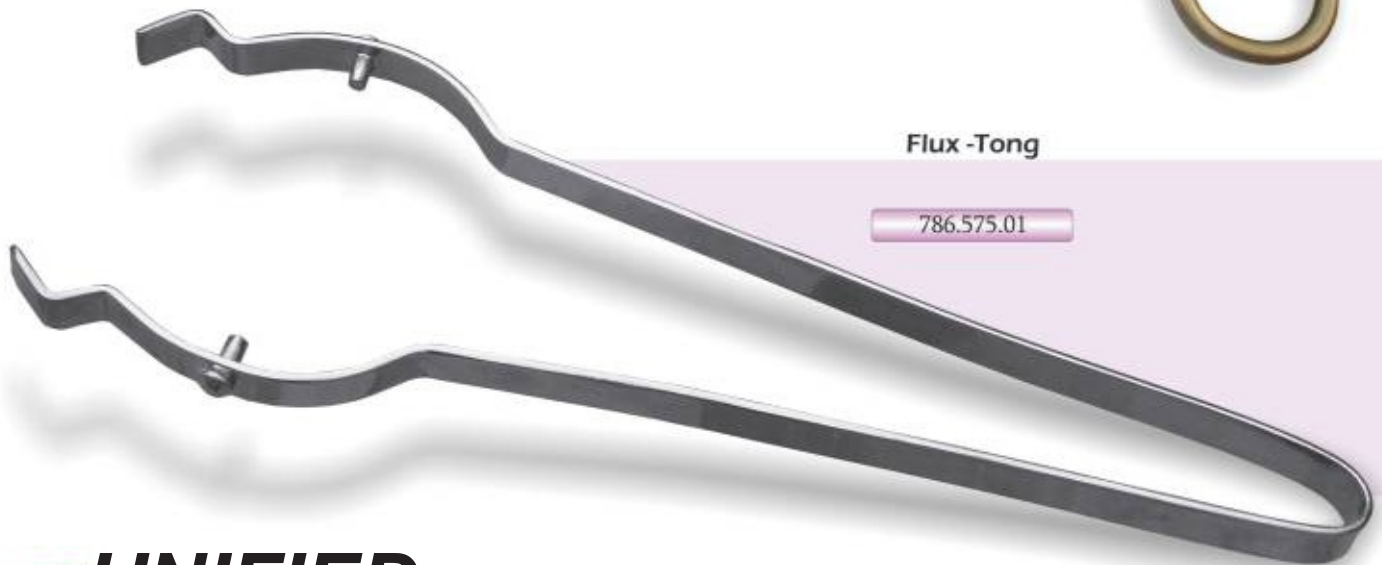



Draw Tong

size 12 inch

786.576.01

Serrated jaw



Draw Tong

Size 12 inch

786.577.01

Serrated jaw



Draw Pliers

Size 140mm

786.578.01



Regular Pliers Kit 5 Pieces

Size 130mm

786.579.01

Kit Contain
Chain Nose, Flat Nose,
Round Nose, Flat & Half Round,
Side Cutter



Pliers Kit of 6 Pieces

Size 130mm

786.580.01

Kit Contain
Chain Nose, Flat Nose,
Chain Bent Nose, Round Nose,
Parallel Flat Smooth Jaw 140 mm,
Side Cutter



Regular Pliers Kit 5 Pieces

Size 115mm

786.581.01

Kit Contain
Chain Nose, Flat Nose,
Round Nose, Chain Bent Nose Pliers,
Side Cutter



You can make your own custom kit with different pliers

Ergonomic Handle Pliers Kit



Size 130mm

786.582.01

Chain Nose, Flat Nose
Round Nose, Flat & Half Round
Side Cutter



Pliers Kit of 5 Pieces



Size 115mm
Ergo Pliers Kit

786.583.01

Chain Nose, Flat Nose
Chain Bent Nose, Round Nose
Side Cutter



Pliers Kit of 5 Pieces



Size 115mm
Ergo Handle

786.584.01

Chain Nose, Flat Nose
Round Nose, Flat & Round
Side Cutter





Precision Pliers Kit of 4 Pieces

Size 120 mm

786.585.01

Chain Nose
Flat Nose
Round Nose
Side Cutter



Ergo Long Handle Pliers Kit 7 Pieces

Size 150mm

786.586.01

Chain Nose
Flat Nose
Chain Bent Nose
Round Nose
Flat & Half Round
Flat Plastic Jaw
Side Cutter



Parallel Pliers Kit

786.587.01

Chain Nose 120 mm
Flat Serrated 120 mm
Flat Smooth 140 mm
Flat & Half Round 140 mm
Plastic Flat
Side Cutter



Pliers Kit of 10 Pieces



786.588.01

Chain Nose 115 mm, Bent Chain Plier 115 mm,
Flat Nose 115 mm, Round Nose Plier 115 mm,
Side Cutter 115 mm, Flat Nylon Plier 117mm,
Tweezer No.4, Steel Ruler,
Brass Gauge, Soldering Pick



Pliers Kit 9 Pieces



786.589.01

Chain Nose 115 mm,
Flat Nose 115 mm,
Side Cutter 115 mm, Flush Cutter 140 mm,
Crimping Plier 140 mm, Flat Nylon Plier 117 mm,
Tweezer No.4, Beading Scoop,
Soldering Pick



Pliers Kit Small

Size 75 mm

786.590.01

Chain Nose, Flat Nose,
Round Nose, Side Cutter



Dapping Block (65 mm Square) 2 1/2 x 2 1/2 inch

786.591.01

| 21 Spheres Holes | | | | |
|------------------|------|------|------|------|
| 2.0 | 9.5 | 17.5 | 27.0 | 50.8 |
| 3.2 | 11.1 | 19.1 | 28.6 | |
| 4.8 | 12.7 | 20.6 | 31.8 | |
| 6.4 | 14.3 | 22.2 | 34.9 | |
| 7.9 | 15.9 | 25.4 | 44.5 | |

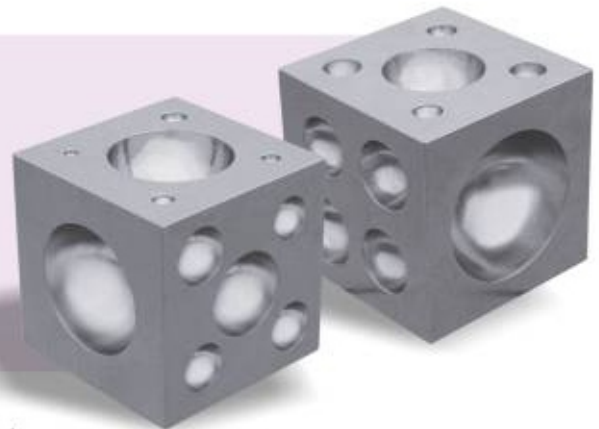

Dapping Set 2 1/2 x 2 1/2 inch

786.592.01

| 21 Punchers | | | | |
|-------------|------|------|------|------|
| 1.3 | 8.7 | 10.8 | 26.3 | 50.1 |
| 2.4 | 10.3 | 18.3 | 27.9 | |
| 4.0 | 11.9 | 19.8 | 31.1 | |
| 5.6 | 13.6 | 21.5 | 34.2 | |
| 7.1 | 15.1 | 24.6 | 43.8 | |

Dapping Block 2 x 2 inch

786.593.01

Carbon Steel

| 17 Half Spheres Holes | | | | |
|-----------------------|------|------|------|------|
| 3.2 | 9.5 | 15.9 | 22.2 | 34.9 |
| 4.8 | 11.1 | 17.5 | 25.4 | |
| 6.4 | 12.7 | 19.1 | 28.6 | |
| 7.9 | 14.3 | 20.6 | 31.8 | |

786.593.02

Brass



Dapping Set 2 x 2 inch

786.594.01

| 17 Punchers | | | | |
|-------------|------|------|------|------|
| 2.4 | 8.7 | 15.1 | 21.5 | 34.2 |
| 4.0 | 10.3 | 16.8 | 24.6 | |
| 5.6 | 11.9 | 18.3 | 27.9 | |
| 7.1 | 13.6 | 19.8 | 31.1 | |



19 Pieces Puncher Set

786.595.21

| 19 Punchers | | | | |
|-------------|------|------|------|------|
| 1.3 | 8.7 | 10.8 | 26.3 | 50.1 |
| 2.4 | 10.3 | 18.3 | 27.9 | |
| 4.0 | 11.9 | 19.8 | 31.1 | |
| 5.6 | 13.6 | 21.5 | 34.2 | |
| 7.1 | 15.1 | 24.6 | 43.8 | |



17 Pieces Puncher Set

786.596.17
17 Pieces Puncher Set

| 17 Punchers | | | | |
|-------------|------|------|------|------|
| 2.4 | 8.7 | 15.1 | 21.5 | 34.2 |
| 4.0 | 10.3 | 16.8 | 24.6 | |
| 5.6 | 11.9 | 18.3 | 27.9 | |
| 7.1 | 13.6 | 19.8 | 31.1 | |

786.196.11
11 Pieces Puncher Set



Dapping Plate Hole 27

Size 135 x 65 x 20 mm

786.597.27
27 Hole Dapping Plate

| 27 Half Spheres | | | | |
|-----------------|-----|------|------|------|
| 1.5 | 4.4 | 8.7 | 14.3 | 19.1 |
| 2.0 | 4.8 | 9.5 | 15.5 | 20.6 |
| 2.4 | 5.6 | 10.7 | 15.9 | 22.2 |
| 2.8 | 6.4 | 11.1 | 17.1 | 23.8 |
| 3.2 | 7.1 | 12.7 | 17.5 | 25.4 |

786.597.14
14 Hole Dapping Plate



Designer Block

Size 95 x 64 x 22 mm

786.598.01

| 14 Spheres | | | | | 8 Half Spheres | | | |
|------------|------|------|------|------|----------------|------|------|------|
| 3.2 | 7.9 | 12.7 | 17.5 | 22.2 | 6.4 | 9.5 | 15.9 | 22.2 |
| 4.8 | 9.5 | 14.3 | 19.1 | 25.4 | 7.9 | 12.7 | 19.1 | 25.4 |
| 5.4 | 11.1 | 15.9 | 20.6 | | | | | |



Designer Block

786.599.01

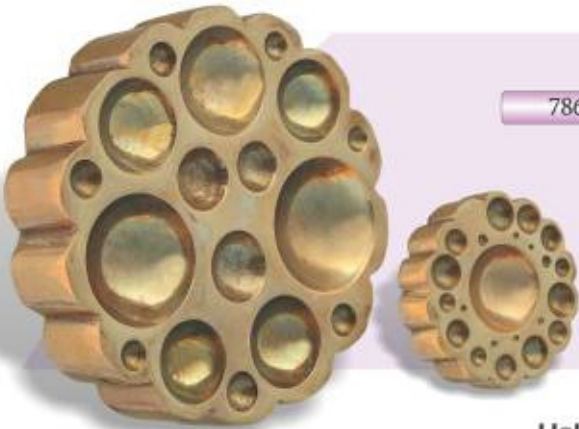

Half Round Rectangle

Size 60 x 60 x 60 mm

786.200.01

19 Grooves of square, V-Slot,
Half Round Rectangle,
Slots of Different Shape & Sizes



Bench Block

Size 4" x 4" x 3/4"

786.201.02

2" x 2"

786.201.03

3" x 3"



Rubber Bench Plate

786.202.05

5" x 5"



Round Large Disc Cutter

786.203.02

Wooden Box Packing

Size 57 mm diameter

786.203.01

Round Shape, Hard Cutter

| 8 Disc Cutter (mm) | |
|--------------------|------|
| 31 | 19 |
| 25 | 16 |
| 23 | 12.5 |
| 21 | 10 |



Small Disc Cutter

Removable 7 Cutter (Round)
Sheet thickness 18 gauge

786.204.01

7 Cutter

| 7 Disc Cutter (mm) | |
|--------------------|---|
| 10 | 6 |
| 9 | 5 |
| 8 | 4 |
| 7 | |

786.204.02

Wooden Box Packing



Disc Cutter Square

786.205.02

Wooden Box Packing

Removable 14 Cutter
Size 100 x 50 mm

786.205.01

14 Cutter

| 14 Disc Cutter (mm) | |
|---------------------|----|
| 14 | 16 |
| 11 | 13 |
| 9 | 12 |
| 8 | 10 |
| 6 | 8 |
| 4.5 | 7 |
| 3 | 5 |



Disc Cutter Square

Removable 7 Cutter
Size 71 x 60 mm

786.206.01

7 Cutter

| 7 Disc Cutter (mm) | |
|--------------------|-----|
| 16 | 9.5 |
| 14.5 | 8.5 |
| 13 | 6.5 |
| 11 | |

786.206.02

Wooden Box Packing



5 Big Disc Cutter Square

Removable 5 Big Cutter
Size 71 x 71 mm

786.207.02

Wooden Box Packing

786.207.01

5 Big Cutter

| 5 Disc Cutter (mm) | |
|--------------------|------|
| 26.5 | 19 |
| 25.5 | 14.5 |
| 22 | |



Removable Disc Cutter Square

5 Small Cutter
12 gauge Sheet.

786.208.01

5 Small Cutter

786.208.02

Wooden Box Packing

| 5 Disc Cutter (mm) | |
|--------------------|-----|
| 11 | 4.5 |
| 8 | 2.5 |
| 5 | |

Disc Cutter with Lever

Removable 12 Cutter

786.209.02

Wooden Box Packing

786.209.01

12 Cutter

| 12 Disc Cutter (mm) | | 8 Pin Cutter (mm) | |
|---------------------|----|-------------------|----|
| 15.5 | 10 | 15.5 | 11 |
| 14.5 | 9 | 15 | 9 |
| 14 | 8 | 14 | 8 |
| 13.5 | 7 | 13.5 | 7 |
| 12.5 | 6 | | |
| 11 | 5 | | |



Hole Making Diy

24 Gauge

786.210.01

1.60 x 2.30 mm

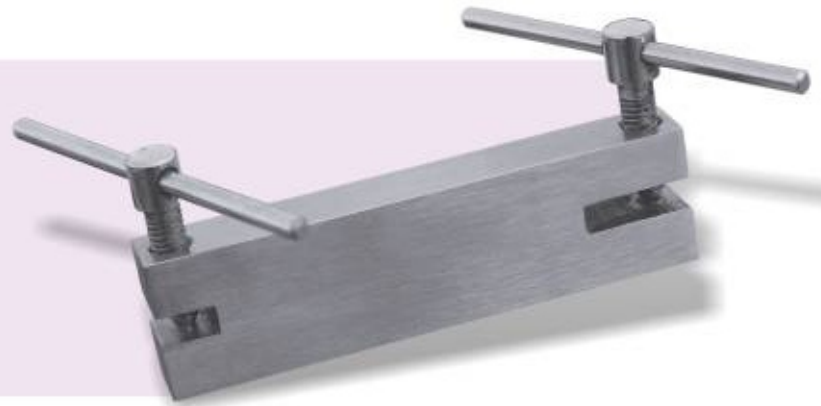

Reamers

786.211.01

Small



Reamers

786.212.01

Medium



Reamers

786.213.01

Large



NIQUA®



Golden Eye - Orange

786.214.01

Superb Quality for Jewelers, goldsmiths and silversmiths extremely flexible, straight cut, long periods of utilization, 130 mm long, yellow color, wound in yellow wire

Golden Eye - Black

786.215.01

Superb Quality for Jewelers, goldsmiths and silversmiths extremely flexible, straight cut, long periods of utilization, 130 mm long, yellow color, wound in yellow wire



Golden Eye - Neutral

786.216.01

Superb Quality for Jewelers, goldsmiths and silversmiths extremely flexible, straight cut, long periods of utilization, 130 mm long, yellow color, wound in yellow wire



Nashorn

786.217.01

Well suited for cutting light and soft metals, round back, 130 mm long, blue color



Expert

786.218.01

Top quality saw blades for soft metals, 130 mm long yellow color, bundled by the dozen in flat pouches



Herkules

786.219.01

Quality precision saw blades for metals, as well as for jewelry and goldsmith applications, 130 mm long.



For detail on NIQUA products, please visit www.niqua.de



Steel Bur Tool

Cylinder, Squared

786.226.01

Steel Bur Tool

cylinder, rounded

786.227.01



Steel Bur Tool

Cone, Squared

786.228.01

Steel Bur Tool

Crown Plate Saw

786.229.01



Steel Bur Tool

Twist Drill

786.230.01

Steel Bur Tool

Cylinder, Rounded

786.231.01



Steel Bur Tool

Flame

786.232.01

Steel Bur Tool

Krause

786.233.01



For detail on NIQUA products,
please visit www.niqua.de



Steel Bur Tool
Double Cone Bearing Cutter

786.234.01



Steel Bur Tool
Double Cone Bearing Cutter

786.235.01



Steel Bur Tool
Double Cone Bearing Cutter

786.236.01



Steel Bur Tool
Knife-Edge Cutter

786.237.01



Steel Bur Tool
Wheel

786.238.01

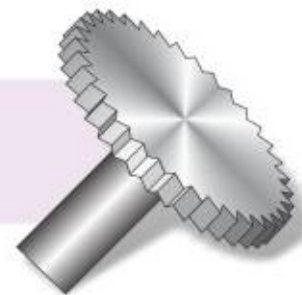

Steel Bur Tool
Wheel

786.239.01



Steel Bur Tool
Pointed

786.240.01

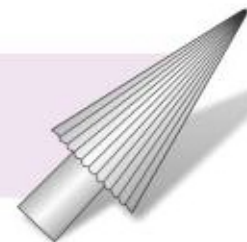

Steel Bur Tool
Pointed

786.241.01



For detail on NIQUA products,
please visit www.niqua.de





Steel Bur Tool
Pointed

786.242.01

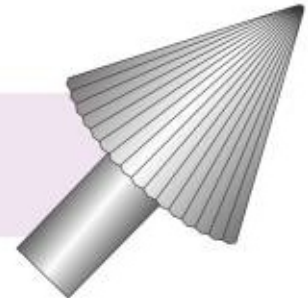

Steel Bur Tool
Cone 90°

786.243.01



Steel Bur Tool
Cone 90°

786.244.01



Steel Bur Tool
Stone Setting Bur

786.245.01



Steel Bur Tool
Cylinder

786.246.01



Steel Bur Tool
Cylinder

786.247.01



Steel Bur Tool
Wheel

786.248.01



Steel Bur Tool
Concave Cutter

786.249.01



For detail on NIQUA products,
please visit www.niqua.de



Steel Bur Tool

Bud

786.250.01



Steel Bur Tool

Helix Wax Bur

786.251.01

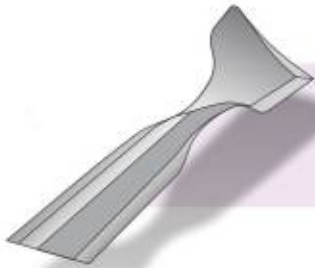

Twist Drill

Tungsten Carbide

786.252.01



Steel Bur

Tungsten Carbide, Rounded

786.253.01



Scut Concave Cutter

786.254.01



Hss Twist Drills

Din 338 Rn

786.255.01



For detail on NIQUA products,
please visit www.niqua.de



Mold Frame

Size 95 x 64 x 25 mm

786.256.01



Combo Ingot Mold

Removable

Size 4 x 46 x 77 mm

786.257.01

4, 5, 6, 7 mm

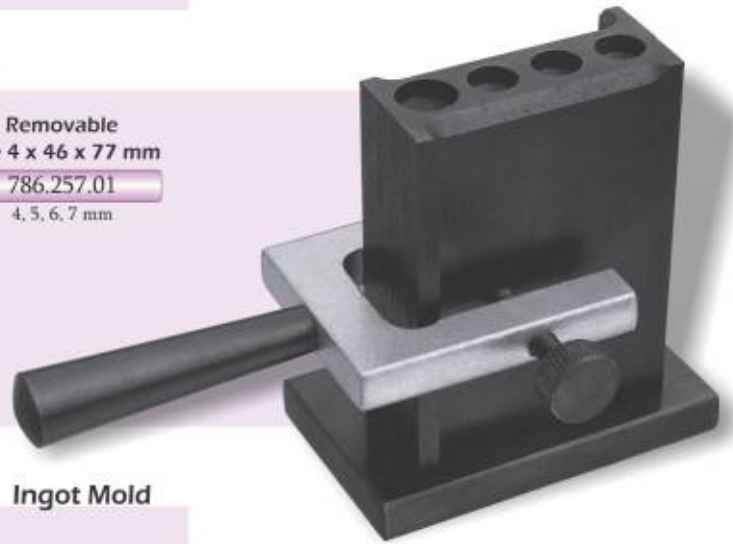

Ingot Mold

786.258.01



Mold Frame

Cavity Size 50 x 75 mm

786.259.01

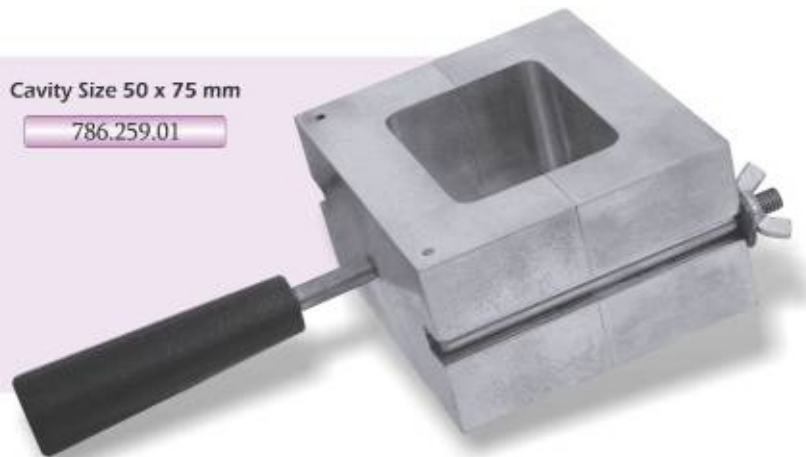

Step Mandrel Round

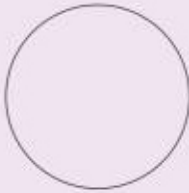

Overall Length 250 mm
Square Tang 36 x 36 mm

786.260.01

Step 2 inch Each
63, 60, 55, 51 mm

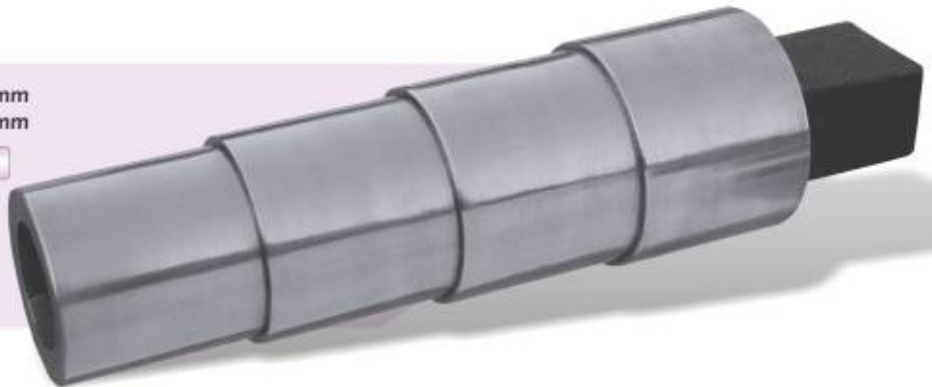

Step Mandrel Oval

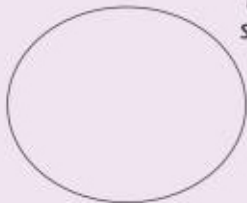

Overall Length 225 mm
Square Tang 36 x 36 mm

786.261.01

Step Length 1 3/4",
63 x 57 mm
57 x 52.5 mm
51 x 47 mm
45 x 41 mm

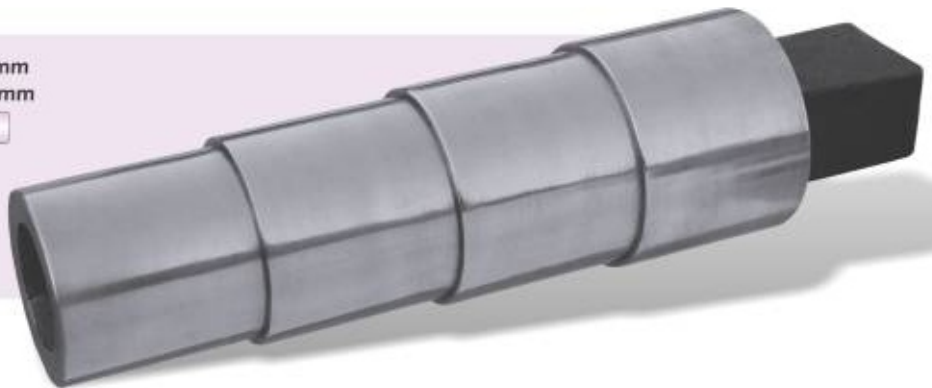

Tapered Round Mandrel

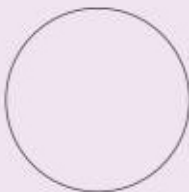

Overall Length 250 mm
Square Tang 36 x 36 mm

786.262.01

Taper from 48.5 mm to 73 mm



Tapered Oval Mandrel

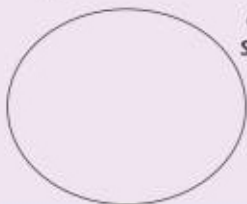

Overall Length 220 mm
Square Tang 36 x 36 mm

786.263.01

66.5 x 62 mm
46 x 41.5 mm

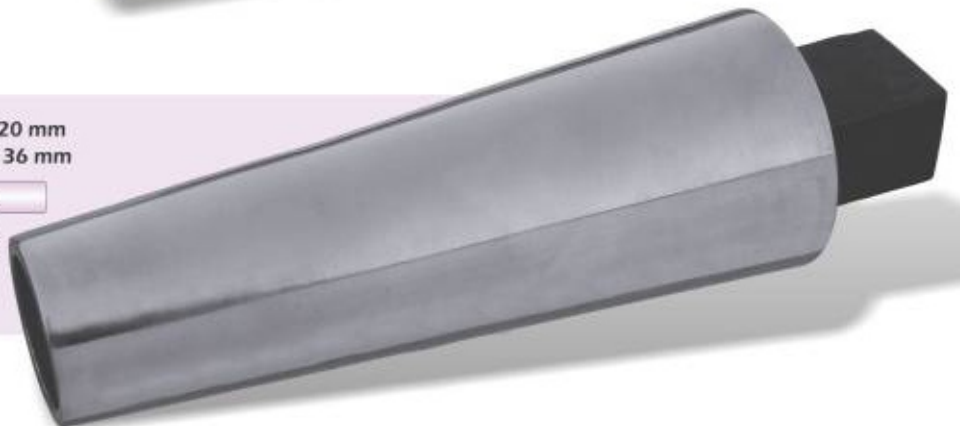

Tapered Round Mandrel



Overall Length 150 mm
Flat Tang 2" x 3" x 7.9 mm

786.264.01

Old Style

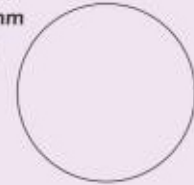

Tapered Oval Mandrel



Overall Length 150 mm
Flat Tang 2" x 3" x 7.9 mm

786.265.01

Old Style

70 x 65 mm

44.5 x 38 mm

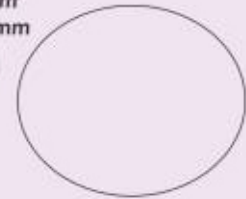

Tapered Round Mandrel

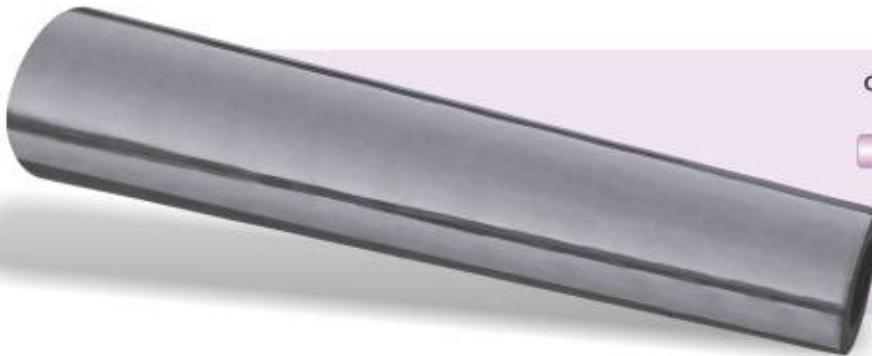

Overall Length 15"
Without Tang

786.266.01

75 mm

37.5 mm

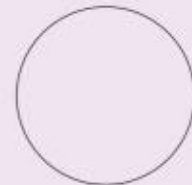

Tapered Oval Mandrel

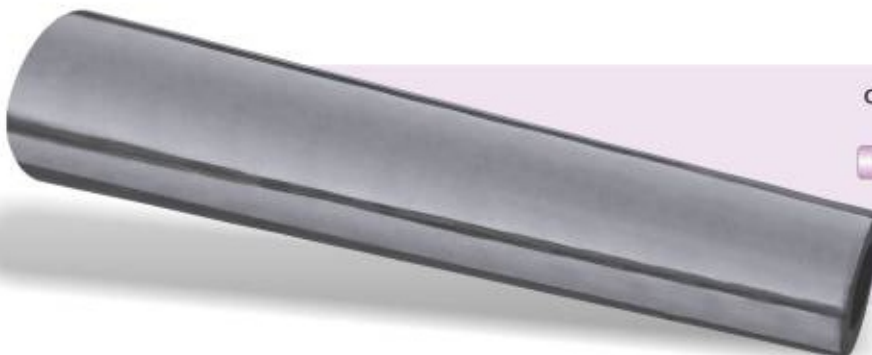

Overall Length 15"
Without Tang

786.267.01

75 x 70 mm

31 x 34 mm

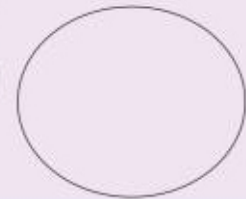
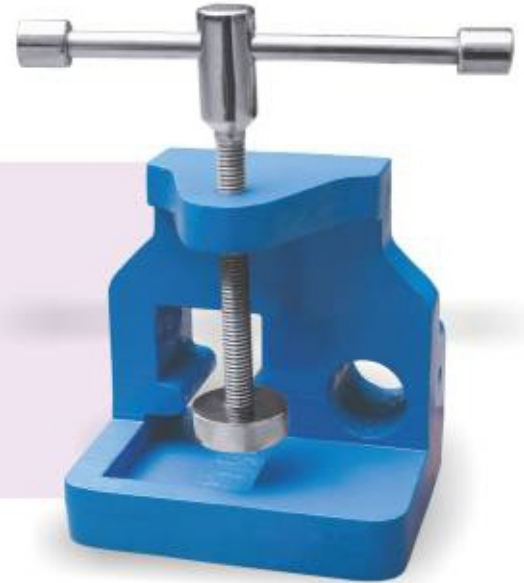



**Table Mandrel Vice
That Fits to Mandrel**

786.268.01

Bench Hole Pin Size 51 mm x 15 mm
Square Hole Size 40 mm x 32 mm
Round Hole 27 mm



Large Tapered Ring Mandrel

Solid Steel, No Marks, Plain

786.269.01

Tapered Gradually from
12 mm to 24 mm



Ring Mandrel

Size A-Z+6

786.270.01

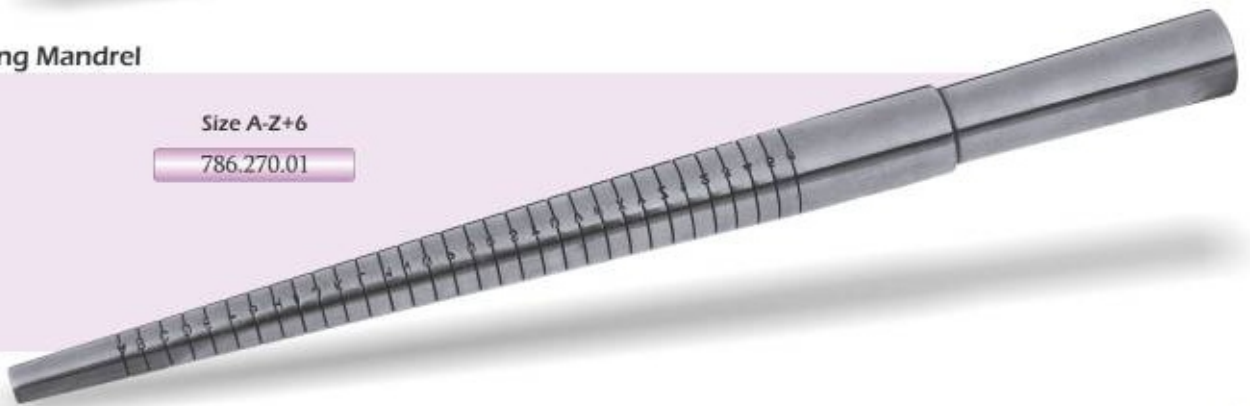

Ring Mandrel A-Z

786.271.01





Ring Mandrel

US Size 1 - 15

786.272.01



Ring Mandrel

Size A - H

786.073.01



Ring Mandrel

1-8-U.S.
Aluminum Ring Mandrel Set
& Ring Sizer

786.274.01



Pin Removing Pliers

Size 130mm

786.275.01

Round Fine Pointed U-Type Flat



Watch Adjustment Pliers

Size 125mm

786.276.01

Round Nose
Flat Nose Slightly Tapered Flat Point,
Round Nose Fine Point



Special Handle Watch Adjustment Pliers

Size 130mm

786.277.01



Fixo-Flex Pliers

Size 115mm

786.278.01

Size of hole 0.6mm

786.278.02

Size of hole 0.7mm



Pin Removing Pliers

- 786.279.02
Spare Pin 0.8 mm
- 786.279.03
Spare Pin 1 mm
- 786.279.04
Spare Pin 1.2 mm
- 786.279.05
Spare Pin 1.5 mm
- 786.279.06
Spare Spring

Size 0.8mm

786.279.01
Complete Plier



Set of Pin Removing Pliers

786.280.01
Complete Set
Including
Spare Pin 0.8, 1, 1.2 mm
& Spare Spring



Pin Removing Base

786.281.01

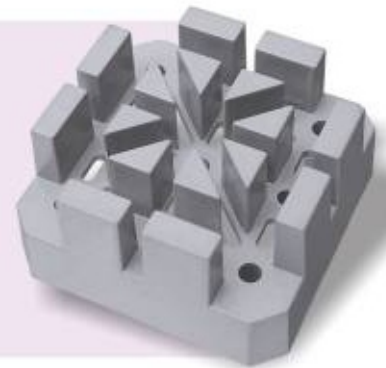

Pin Remover

786.282.01
Complete Set

786.282.02
Spare Pin
0.7 mm

786.282.03
Spare Pin
0.9 mm

786.282.04
Spare Spring





Punch Pliers Different size Hole

Size 170mm

786.283.01

Hole size
0.70 mm dia,
1 mm dia,
1.5 mm dia,
2.5mm dia



Punch Pliers

Size 140mm

786.284.01

Size of hole 1.5 mm
Polish Handle

786.284.02

Size of hole 2 mm
Polish Handle



Punch Pliers

Size 140mm

786.285.01

Size of hole 1.5 mm
Matt Grip Handle

786.285.02

Size of hole 2 mm
Matt Grip Handle



Punch Pliers for

Brass or Copper
Special Handles
Plate size 140 mm

786.286.01

Size of Pin 2 mm

786.286.02

Pack of 6 Spare Pins



Leather Strap Cutter



Size 140 mm
Polish Handle

786.287.01

Cutting 1.5 mm

786.287.02

Cutting 3 mm



Leather Strap Cutter



Size 140 mm

786.288.01

Cutting 1.5 mm

PVC Coated Handle

Double Leaf Spring

786.289.02

Cutting 3 mm

PVC Coated Handle

Double Leaf Spring



Watch Case Opener

Jaxa Type

786.290.01



Pocket Watch Case Opener

786.291.01





**Large Watch Case Close
Teflon Head**

786.296.01



18 mm

22 mm

24 mm

25 mm

**Small Watch Case Close
Teflon Head**

786.297.01



16 mm

18 mm

20 mm

22 mm



Dust Blower

786.298.01



Screw Driver Set

10 Pieces

786.299.01

786.299.02

Spare Blade

Screw Driver Set

4 Pieces

786.300.01

786.300.02

Spare Blade



Screw Driver Set

5 Pieces

786.301.01

786.301.02

Spare Blade



Screw Driver

786.302.01



Screw Driver

786.303.01

786.303.02
Spare Blade



Screw Driver

786.304.01

786.304.02
Spare Blade



Screw Holder

786.305.01

786.305.02
Spare Blade





Brass Hammer Large

Overall Length 9 $\frac{3}{4}$ "

Weight 2 lb

786.306.01

35 mm Diameter



Brass Hammer Large

Overall Length 9 $\frac{3}{4}$ "

Weight 1 lb

786.307.01

25 mm Diameter

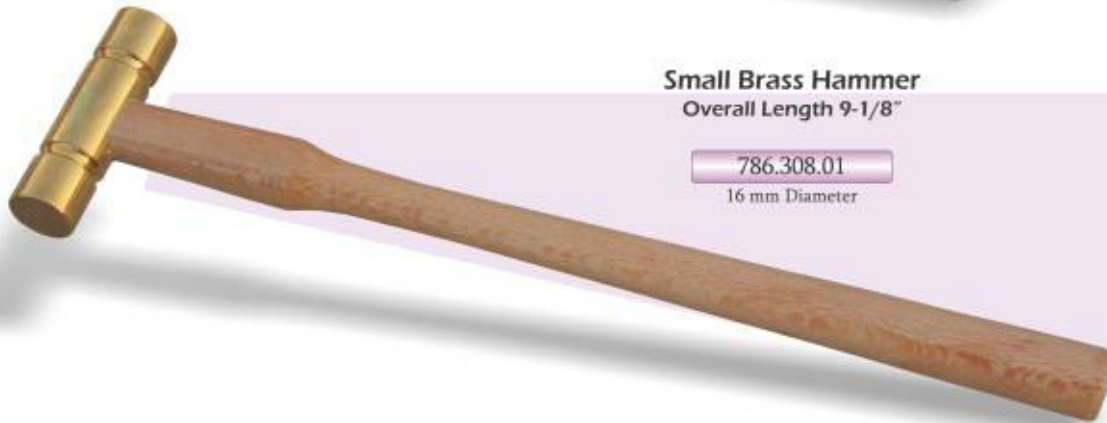

Small Brass Hammer

Overall Length 9-1/8"

786.308.01

16 mm Diameter



Large Brass + Teflon Hammer

786.309.01

Flat Brass, Domed Nylon

Domed Brass, Flat Nylon

Teflon Hammer one Side Flat other Domed

786.310.01



Small Brass + Teflon Hammer
Overall Length 9 1/4"

786.311.01

16 mm Diameter

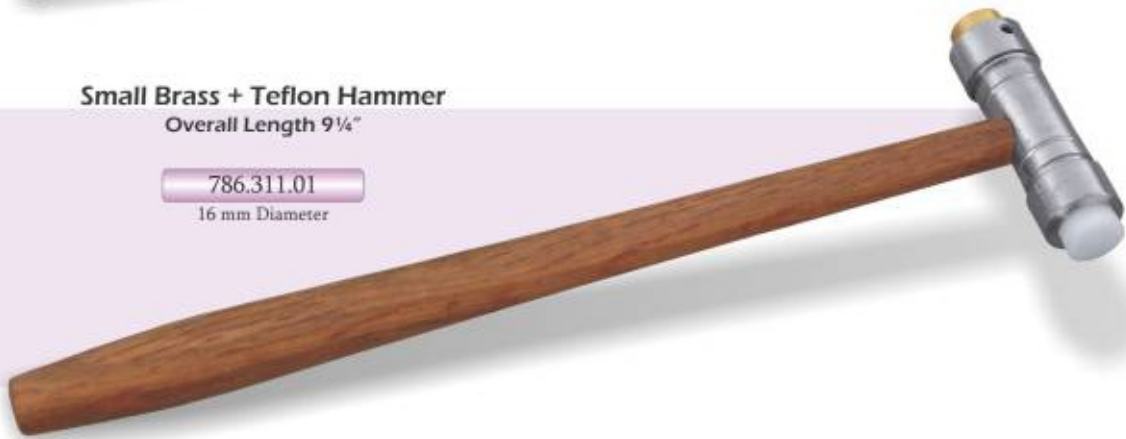

Small Goldsmith Hammer

786.312.01

Flat Brass, Domed Nylon
Domed Brass, Flat Nylon

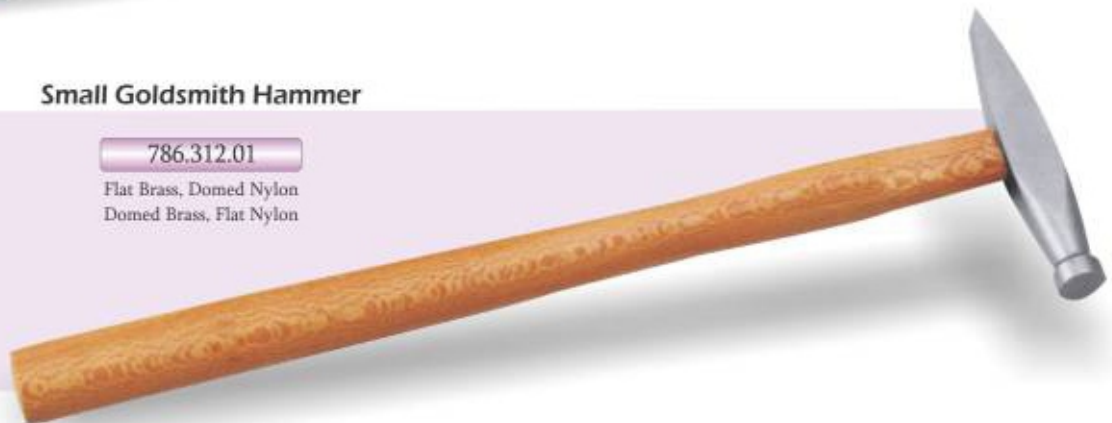

Set of Designer Hammer
with 9 interchangeable heads

786.313.01

Checkerboard, Diamonds,
Wide Stripe Rain, Mt. Everest, Moonscape
Single Round, Single Square, Dimple





Designer Hammer 1

786.314.01

Round Checkered
& Wide Pine Strip.



Designer Hammer 2

786.315.01

Round Dimple & Narrow Strip



Designer Hammer 3

786.316.01

Rectangular Star
& Diamond.



Set of Designer Hammer 1-3

786.317.01

Chasing Hammer Flat Head

- 786.318.01
Size 22mm
- 786.318.02
Size 25mm
- 786.318.03
Size 28mm
- 786.318.04
Size 32mm



Chasing Hammer Slightly Domed Shape Head

- 786.319.01
Size 22mm
- 786.319.02
Size 25mm
- 786.319.03
Size 28mm
- 786.319.04
Size 32mm



Gold Smith Hammer Flat Head

- 786.320.01
Size 12mm
- 786.320.02
Size 16mm
- 786.320.03
Size 18mm



Gold Smith Hammer Domed Head

- 786.321.01
Size 12mm
- 786.321.02
Size 16mm
- 786.321.03
Size 18mm



Gold Smith Dimacus Hammer

- 786.322.01
Size 12mm
- 786.322.02
Size 16mm
- 786.322.03
Size 18mm



Watch Hammer



786.323.50
Head size 50 mm

786.323.60
Head size 60 mm

786.323.70
Head size 70 mm

786.323.80
Head size 80 mm

786.323.90
Head size 90 mm

786.323.100
Head size 100 mm

Teflon Hammer Overall Length 10¾"



786.324.01
Head 38 mm diameter

Teflon Hammer

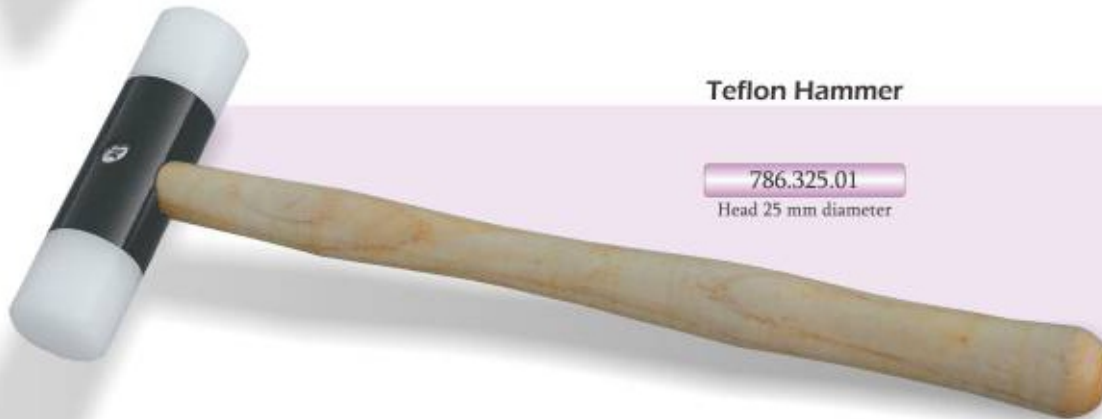

786.325.01
Head 25 mm diameter

Tri-Head, 3 in one Hammer Overall Length 9"



786.326.01
Brass Domed, Nylon Domed,
Steel Domed.

Chasing Hammer

Face Diameter 29 mm
Face Profile Slightly Domed
Other Side 12.5 mm
Head Length 65 mm
Overall Length 12"

786.327.01



Chasing Hammer

Face Diameter 24 mm
Face Profile Slightly Domed / Other Side Flat
Head Length 75 mm
Overall Length 10"

786.328.01



Planishing Hammer

Face Diameter 13 mm
Face Profile Slightly Domed / Other Side Flat
Head Length 63 mm
Overall Length 9"

786.329.01



Wide Raising Hammer

Face 4 x 13 mm & 6 x 13.5 mm
Face Profile Slightly Round
Head Length 65 mm
Overall Length 9"

786.330.01



Narrow Raising Hammer

Face 3 x 14 mm & 4 x 14 mm
Face Profile Slightly Round
Head Length 66 mm
Overall Length 9"

786.331.01





786.332.01

Designer Hammer

Face Diameter 19 mm
Face Profile One Side Texture
Other Side Plain
Head Length 72 mm
Overall Length 9"



786.333.01

Sharp Designer Hammer

Face Profile Sharp
Head Length 73 mm
Overall Length 9"



786.334.01

Embossing Designer Hammer

Head Size 8.3 mm / 9.9 mm
Head Length 65 mm
Overall Length 9"



786.335.01

Embossing Designer Hammer

Head Size 1.9 mm / 8.3 mm
Head Length 65 mm
Overall Length 9"



Set of Designer Hammer

- 1. Wide Rasing Hammer
- 2. Sharp Designer Handle
- 3. Embossing Hammer - Large
- 4. Embossing Hammer - Small
- 5. Designer Hammer - Silk Pattern
- 6. Narrow Rasing Hammer

786.336.01



Embossing Hammer

Face One Side 11 mm
Other Side 14 mm
Head Length 105 mm
Overall Length 10"

786.337.01



Embossing Hammer

Face One Side 18 mm
Other Side 21 mm
Head Length 115 mm
Overall Length 12"

786.338.01



Planishing Hammer

One Side Flat 22 mm
Other Side Slightly Domed 23 mm
Head Length 135 mm
Overall Length 12"

786.339.01



Planishing Hammer

One Side Flat 23 mm
Other Side Slightly Domed 23 mm
Head Length 80 mm
Overall Length 12"

786.340.01





786.341.01

Planishing Hammer

Round Side Diameter 28 mm
Other Flat Side 32 x 8 mm
Head Length 120 mm
Overall Length 12"



786.342.01

Planishing Hammer

Round Side Diameter 23 mm
Other Flat Side 21 x 21 mm
Head Length 95 mm
Overall Length 12"



786.343.01

Planishing Hammer

One Side Slightly Domed 25 x 25 mm
Other Flat Side 25 x 25 mm
Head Length 100 mm
Overall Length 12"



786.344.01

Rasing Hammer

One Side 36 x 10 mm
Other Flat Side 36 x 12 mm
Head Length 115 mm
Overall Length 12"

Forming Hammer

Face One Side Low Domed 31 mm
Other Side High Domed 30 mm
Head Length 115 mm
Overall Length 12"

786.345.01



Forming Hammer

Face One Side Low Domed 30 mm
Other Flat Side 30 mm
Head Length 115 mm
Overall Length 12"

786.346.01

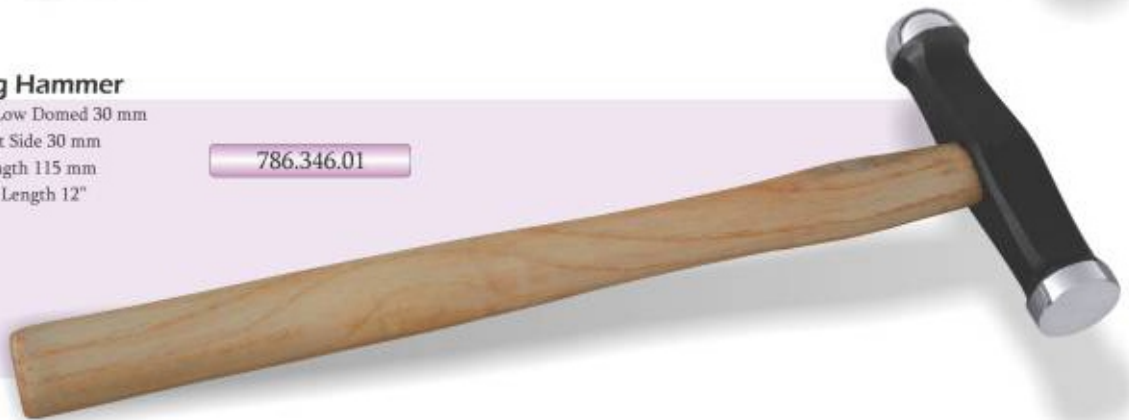

Rasing Hammer

Face One Side 32 x 17 mm
Other Side 31 x 20 mm
Head Length 120 mm
Overall Length 12"

786.347.01



Grooving Hammer

Face Both Side 22 x 4 mm
Head Length 145 mm
Overall Length 12"

786.348.01

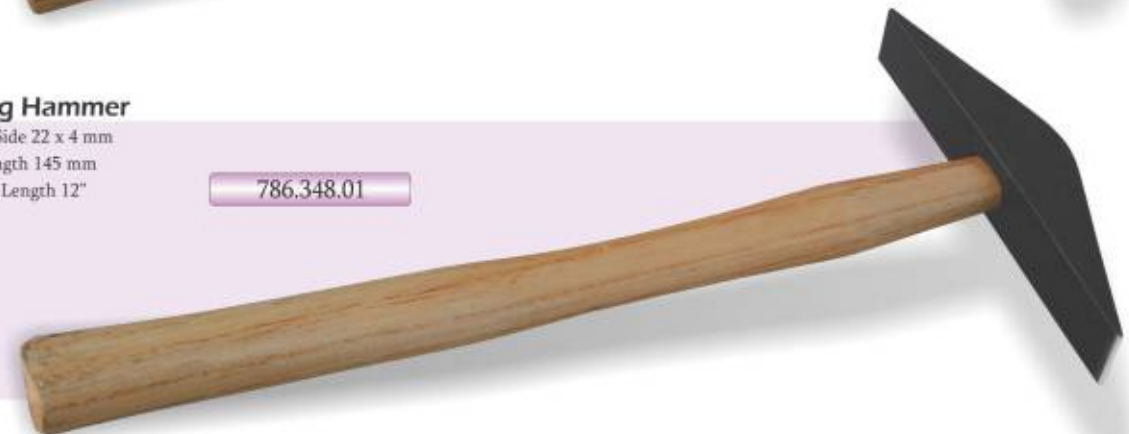



Grooving Hammer

Face Both Side 20 mm
Head Length 115 mm
Overall Length 12"

786.349.01



Ball Pein Hammer

Head Length 115 mm
Overall Length 9"

786.350.01
Weight 2 Ounce

786.350.02
Weight 4 Ounce



Leather Hammer

Head Diameter 32 mm
Head Length 66 mm
Overall Length 12"

786.351.01



Plastic Hammer

Head Diameter 22 mm
Head Length 65 mm
Overall Length 10"

786.352.01



Stationary Hammer

Head Diameter 60 & 80 mm
Both sizes of 60 & 80 mm comes with hammer
Easily Changeable

786.353.01





Divider

786.354.01

3 inch

786.354.02

4 inch

Divider

With Replacement Legs

786.355.01

3 inch

786.355.02

Spare Replacement Legs



Divider

With Replacement Legs

786.356.01

3 inch

Divider

786.357.01

3.5 inch





Protractor

786.358.01



Scale

786.359.06
6 Inch

786.359.12
12 Inch



Magnifying Glass

786.360.01

Jewellers Calipers

Size 1/10mm

786.361.01



Jewellers Calipers

Size 1/15mm

786.362.01



Boleg Gauge

786.363.01



Brass Boleg Gauge

786.364.01





Optical Calipers

786.365.01



Optical Calipers

786.366.01



Optical Calipers

786.367.01

Wire Gauge

786.368.01



L-Square

786.369.01
Size 70mm

786.369.02
Size 90mm



Vernier Calipers

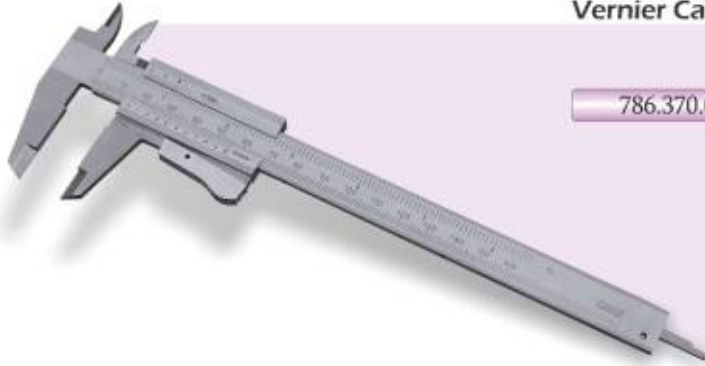

786.370.01



Dial Gauge Size 150mm

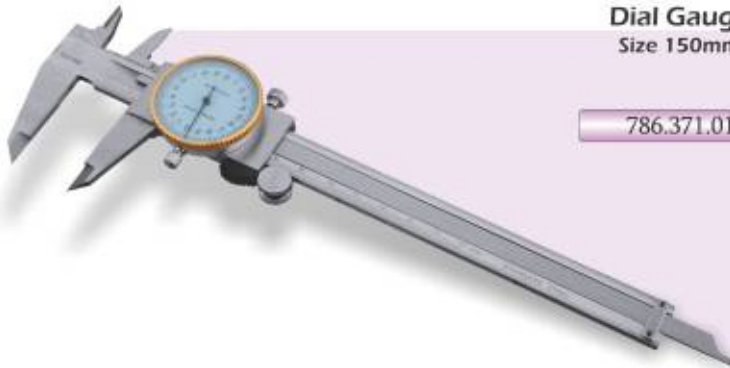

786.371.01



Digital Calipers Size 150mm



786.372.01



Pearl Gauge



786.373.01





AA Titanium Tweezer

Length 130 mm

786.374.01



Diamond Titanium Tweezer

Length 160 mm

786.375.01



Diamond Titanium Tweezer

Length 160 mm
(Black Coated)

786.376.01



Titanium Tweezer

No. 3
Length 120 mm

786.377.01



Titanium Tweezer

No. 5
Length 120 mm

786.378.01



AA Tweezer

Length 120 mm

786.379.01

Carbon Steel

786.379.02

Non Magnet / Anti Acid



AA Tweezer

Length 120 mm
Brass

786.380.01



Tweezer M

Length 130 mm

786.381.01

Carbon Steel

786.381.02

Non Magnet / Anti Acid

Tweezer No.1

Length 120 mm

786.382.01
Carbon Steel

786.382.02
Non Magnet / Anti Acid

Tweezer No.2

Length 120 mm

786.383.01
Carbon Steel

786.383.02
Non Magnet / Anti Acid

Tweezer No.2A

Length 120 mm

786.384.01
Carbon Steel

786.384.02
Non Magnet / Anti Acid

Tweezer No.3

Length 120 mm

786.385.01
Carbon Steel

786.385.02
Non Magnet / Anti Acid

Tweezer No.3C

Length 110 mm

786.386.01
Carbon Steel

786.386.02
Non Magnet / Anti Acid

Tweezer No.4

Length 110 mm

786.387.01
Carbon Steel

786.387.02
Non Magnet / Anti Acid

Tweezer No.5

Length 110 mm

786.388.01
Carbon Steel

786.388.02
Non Magnet / Anti Acid

Tweezer No.5A

Length 110 mm

786.389.01
Carbon Steel

786.389.02
Non Magnet / Anti Acid

Tweezer No.6

Length 120 mm

786.390.01
Carbon Steel

786.390.02
Non Magnet / Anti Acid

Tweezer No.7

Length 115 mm

786.391.01

Carbon Steel

786.391.02

Non Magnet / Anti Acid

Tweezer No.7A

Length 110 mm

786.392.01

Carbon Steel

786.392.02

Non Magnet / Anti Acid

Tweezer OO

Length 120 mm

786.393.01

Carbon Steel

786.393.02

Non Magnet / Anti Acid

Tweezer S-Type

Length 120 mm

786.394.01

Carbon Steel

786.394.02

Non Magnet / Anti Acid

Tweezer SS

Length 140 mm

786.395.01

Carbon Steel

786.395.02

Non Magnet / Anti Acid

Tweezer F

Length 170 mm

786.396.01

Carbon Steel

786.396.02

Non Magnet / Anti Acid

Soldering Tweezer

Length 140 mm

786.397.01

Carbon Steel

786.397.02

Non Magnet / Anti Acid

Diamond Lock Tweezer

Length 160 mm

786.398.01

Carbon Steel

786.398.02

Non Magnet / Anti Acid

Diamond Tweezer

Length 160 mm

786.399.01

Carbon Steel

786.399.02

Non Magnet / Anti Acid



Diamond Tweezer
Length 160 mm
Black Coated

786.400.01
Carbon Steel

786.400.02
Non Magnet / Anti Acid



Fiber Tweezer Curved
Length 160 mm

786.402.01
Carbon Steel

786.402.02
Non Magnet / Anti Acid



Fiber Tweezer Straight
Length 160 mm

786.401.01
Carbon Steel

786.401.02
Non Magnet / Anti Acid

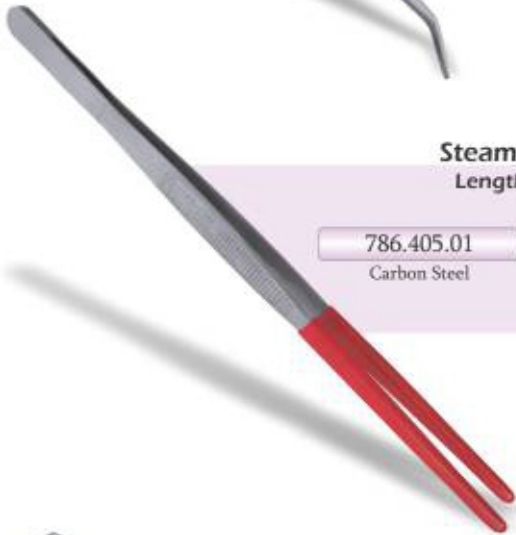

Steam Tweezer
Length 190 mm

786.405.01
Carbon Steel

786.405.02
Non Magnet / Anti Acid



Soldering Tweezer
Length 170 mm

786.403.01
Carbon Steel

786.404.02
Non Magnet / Anti Acid



Diamond Lock Tweezer

786.407.01
Small

786.407.02
Large



Cross Lock Tweezer
Length 140 mm

786.406.01
Carbon Steel

786.406.02
Non Magnet / Anti Acid



Plastic Tweezer
Length 130 mm

786.408.01



Chain Bent Nose Pliers

Size 160 mm

786.409.01

PVC Coated Handle



Chain Nose Pliers

Size 160 mm

786.410.01

PVC Coated Handle

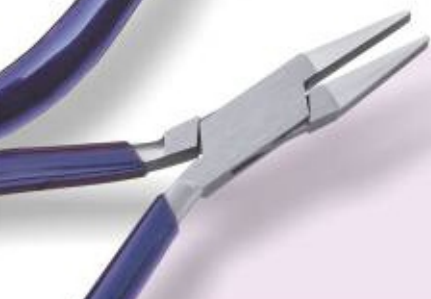

Flat Nose Plier

Size 160mm

786.411.01

PVC Coated Handle



Round Nose Plier

Size 160mm

786.412.01

PVC Coated Handle



Combination, Chain & Round Nose Plier

Size 160mm

786.413.01

PVC Coated Handle



Double Flat Plastic Jaw Plier

Size 160mm

786.414.01

PVC Coated Handle



Round Nose Steel & Flat Plastic Jaw Plier

Size 160mm

786.415.01

PVC Coated Handle



Chain Steel & Flat Plastic Jaw Plier

Size 160mm

786.416.01

PVC Coated Handle



Bending Plier

Size 160mm

786.417.01

PVC Coated Handle



Side Cutter

Size 160mm

786.418.01

PVC Coated Handle

786.418.02

PVC Coated Handle
With Tungsten Carbide Insert





End Cutter

Size 160mm

786.419.01

PVC Coated Handle

786.419.02

PVC Coated Handle
With Tungsten Carbide Insert



Nose Pad Adjusting Plier

Size 160mm

786.420.01

With double leaf spring
Smooth Jaw
PVC Coated Handle



Nose Pad Adjusting Plier

Size 160mm

786.421.01

PVC Coated Handle



Optical Plier

Size 160mm

786.422.01

PVC Coated Handle



Size Testing Plier

Size 160mm

786.423.01

PVC Coated Handle



Optical Plier

Size 160mm

786.424.01

With double leaf spring

Smooth Jaw

PVC Coated Handle



Optical Pliers

Size 160mm

786.425.01

PVC Coated Handle



Lens Turning Plier

Size 190mm

786.426.01

PVC Coated Handle



Metal Stand

786.427.01



Wooden Stand

786.428.01



**Wooden Stand
for 5 Pieces**

786.429.01



**Wooden Stand
for 4 Pieces**

786.430.01



Micro Torch Holder

786.431.01



Magnet Tray

786.432.01





Unified Corporation

Manufacturer & Exporter

PAKISTAN OFFICE

+923006168658

 **+923316620260**

info@unifiedcorporation.com

USA OFFICE

Zahid Ali

0012026155574

Ali.zahid52@yahoo.com

USA Address

5800 quantrell ave #1511 Alexandria VA 22312

**New Adalat Garha Ugoki Road
Sialkot Pakistan**